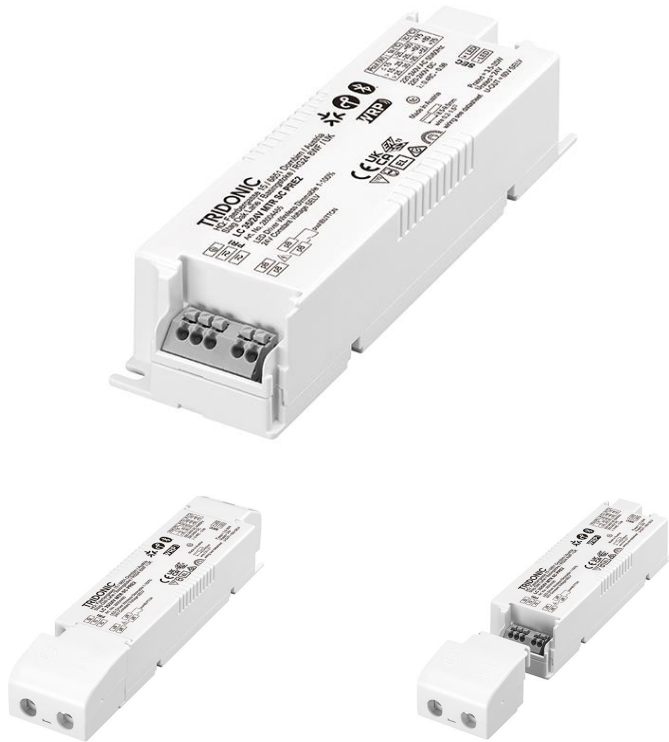

Driver LC 35W 24V MTR SC PRE2

premium series 24 V – dimmable (IP20)

**Product description**

- _ Available soon
- _ Matter certified device
- _ Communication via an IPv6 Thread Network
- _ Thread Border Router is required (e.g. Apple HomePod mini or Google NestHub)
- _ Independent push-button input for free configuration
- _ Wireless firmware updates possible
- _ Dimmable 24 V constant voltage LED driver for flexible constant voltage strips
- _ Can be either used built-in or independent with clip-on strain-relief (see data sheet chapter: 1. Standards)
- _ The strain relief is included in both packaging variants. In the single packaging (SP) each Driver has also an individual packaging
- _ Dimming range 1 to 100 %
- _ No additional external dimmer is needed
- _ Suitable for emergency escape lighting systems acc. to EN 50172
- _ Nominal lifetime up to 50,000 h
- _ 5 years guarantee (conditions at www.tridonic.com)

Typical applications

- _ Cove lighting, facade accent lighting, ceiling integration

Technical details

- _ 24 V, 35 W
- _ Small design (195 x 43 x 30.2 mm) with stretched-compact strain relief
- _ Small cross section
- _ Push terminals for simple wiring
- _ 1 output channel (+/-)

Interfaces

- _ Matter
- _ Terminal blocks: 45° push terminals

System solution

- _ Tridonic LLE-FLEX ADV 600, 1,200, 1,800 lm/m
- _ Tridonic LLE-FLEX EXC 600, 1,200, 1,800, 2,500 lm/m
- _ In connection with Flex accessories wire to PCB plug
- _ Test the function of third party light sources before use at low dimming levels to ensure the dimming function works perfectly

Website

<http://www.tridonic.com/28004485>



Spotlights



Downlights



Linear



Area



Floor | Wall



Free-standing



Street



Decorative



High bay

Driver LC 35W 24V MTR SC PRE2

premium series 24 V – dimmable (IP20)

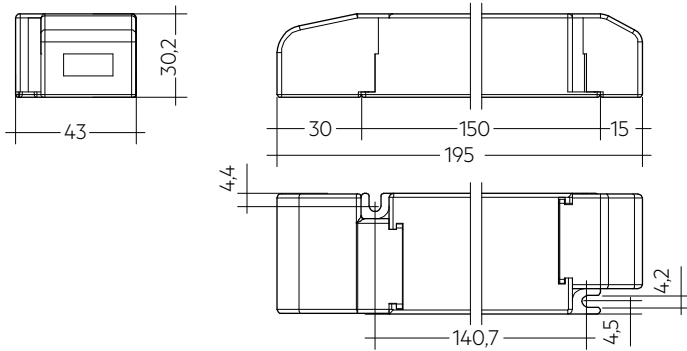

With strain-relief

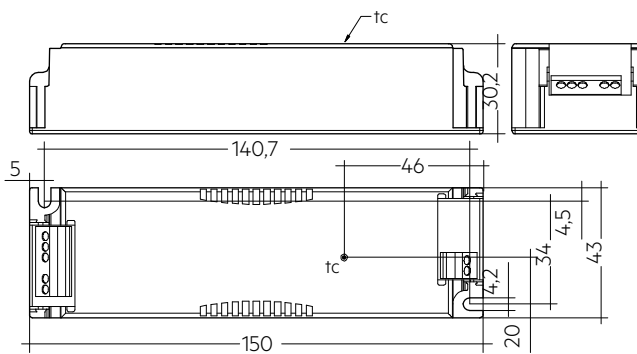

Without strain-relief

Ordering data

Type	Article number	Packaging, carton ^④	Packaging, pallet	Weight per pc.
Multi packaging				
LC 35/24V MTR SC PRE2	28004485	10 pc(s).	390 pc(s).	0.15 kg
Single packaging				
LC 35/24V MTR SC PRE2 SP	28004489	1 pc(s).	1 pc(s).	-

Technical data

Rated supply voltage	220 – 240 V
AC voltage range	198 – 264 V
DC voltage range	176 – 280 V
Mains frequency	0 / 50 / 60 Hz
Typ. rated current (at 230 V, 50 Hz, full load) ^①	176 mA
Typ. current (220 V, 0 Hz, full load, 15 % dimming level)	37 mA
Leakage current (at 230 V, 50 Hz, full load) ^①	< 320 μ A
Max. input power	40 W
Output power range (P _{rated})	3.5 – 35 W
Typ. efficiency (at 230 V, 50 Hz, full load)	89 %
λ over full operating range (max.) ^①	0.98
λ over full operating range (min.)	0.48C
Typ. power consumption on stand-by	< 0.35 W
Typ. input current in no-load operation	26.5 mA
Typ. input power in no-load operation	1.78 W
In-rush current (peak / duration)	21.6 A / 136 μ s
THD (at 230 V, 50 Hz, full load) ^①	< 6.7 %
Starting time (at 230 V, 50 Hz, full load) ^①	< 0.6 s
Starting time (DC mode)	< 0.3 s
Switchover time (AC/DC) ^②	< 0.3 s
Turn off time (at 230 V, 50 Hz, full load)	< 3 ms
Output voltage tolerance	\pm 1 V
Output LF voltage ripple (< 120 Hz)	\pm 5 %
Max. output voltage (U-OUT)	60 V
PWM frequency	~ 1 kHz
Dimming range	1 – 100 %
Mains surge capability (between L - N)	1 kV
Mains surge capability (between L/N - PE)	2 kV
Type of protection	IP20
Radio transceiver operating frequencies	2.4 – 2.483 GHz
Max. output power radio transceiver (E.R.I.P.) [®]	< + 20 dBm
Lifetime	up to 50,000 h
Guarantee	5 Year(s)
Dimensions L x W x H	195 x 43 x 30.2 mm

Approval marks**Standards**

EN 55015, EN 61000-3-2, EN 61000-3-3, EN 61347-1, EN 61347-2-13, EN 62384, EN 61547, ETSI EN 300 330, ETSI EN 301 489-1, ETSI EN 301 489-3, ETSI EN 300 328, ETSI EN 301 489-17, according to EN 50172, according to EN 60598-2-22

Specific technical data

Type	Load	Output voltage	Output current	Max. output power (at full load)	Typ. power consumption (at full load)	Typ. current consumption	t _c point max.	Ambient temperature T _a
LC 35/24V MTR SC PRE2	10 %	24 V	146 mA	3.5 W	5.9 W	41 mA	75 °C	-25 ... +60 °C
LC 35/24V MTR SC PRE2	20 %	24 V	292 mA	7.0 W	9.6 W	57 mA	75 °C	-25 ... +60 °C
LC 35/24V MTR SC PRE2	30 %	24 V	437 mA	10.5 W	13.4 W	71 mA	75 °C	-25 ... +60 °C
LC 35/24V MTR SC PRE2	40 %	24 V	583 mA	14.0 W	17.0 W	85 mA	75 °C	-25 ... +60 °C
LC 35/24V MTR SC PRE2	50 %	24 V	729 mA	17.5 W	20.7 W	99 mA	80 °C	-25 ... +60 °C
LC 35/24V MTR SC PRE2	60 %	24 V	875 mA	21.0 W	24.5 W	114 mA	80 °C	-25 ... +60 °C
LC 35/24V MTR SC PRE2	70 %	24 V	1,021 mA	24.5 W	28.3 W	130 mA	80 °C	-25 ... +60 °C
LC 35/24V MTR SC PRE2	80 %	24 V	1,167 mA	28.0 W	32.0 W	145 mA	75 °C	-25 ... +50 °C
LC 35/24V MTR SC PRE2	90 %	24 V	1,313 mA	31.5 W	35.7 W	161 mA	75 °C	-25 ... +50 °C
LC 35/24V MTR SC PRE2	100 %	24 V	1,453 mA	35.0 W	39.4 W	176 mA	75 °C	-25 ... +50 °C
LC 35/24V MTR SC PRE2 SP	10 %	24 V	146 mA	3.5 W	5.9 W	41 mA	75 °C	-25 ... +60 °C
LC 35/24V MTR SC PRE2 SP	20 %	24 V	292 mA	7.0 W	9.6 W	57 mA	75 °C	-25 ... +60 °C
LC 35/24V MTR SC PRE2 SP	30 %	24 V	437 mA	10.5 W	13.4 W	71 mA	75 °C	-25 ... +60 °C
LC 35/24V MTR SC PRE2 SP	40 %	24 V	583 mA	14.0 W	17.0 W	85 mA	75 °C	-25 ... +60 °C
LC 35/24V MTR SC PRE2 SP	50 %	24 V	729 mA	17.5 W	20.7 W	99 mA	80 °C	-25 ... +60 °C
LC 35/24V MTR SC PRE2 SP	60 %	24 V	875 mA	21.0 W	24.5 W	114 mA	80 °C	-25 ... +60 °C
LC 35/24V MTR SC PRE2 SP	70 %	24 V	1,021 mA	24.5 W	28.3 W	130 mA	80 °C	-25 ... +60 °C
LC 35/24V MTR SC PRE2 SP	80 %	24 V	1,167 mA	28.0 W	32.0 W	145 mA	75 °C	-25 ... +50 °C
LC 35/24V MTR SC PRE2 SP	90 %	24 V	1,313 mA	31.5 W	35.7 W	161 mA	75 °C	-25 ... +50 °C
LC 35/24V MTR SC PRE2 SP	100 %	24 V	1,453 mA	35.0 W	39.4 W	176 mA	75 °C	-25 ... +50 °C

① Valid at 100 % dimming level.

② Valid for immediate change of power supply type otherwise the starting time is valid.

③ E.I.R.P.: Equivalent Isotropically Radiated Power.

④ The strain relief is included in both packaging variants. In the single packaging each Driver has also an individual packaging.

1. Standards

EN 55015
 EN 61000-3-2
 EN 61000-3-3
 EN 61347-1
 EN 61347-2-13
 EN 62384
 EN 61547
 ETSI EN 300 330
 ETSI EN 301 489-1
 ETSI EN 301 489-3
 ETSI EN 300 328
 ETSI EN 301 489-17

According to EN 50172 for use in central battery systems

According to EN 60598-2-22 suitable for emergency lighting installations

For devices with strain-reliefs the following test marks apply:

 ... Class II luminaires

 ... Independent device

For devices without strain-reliefs the following test mark apply:

 ... Double or reinforced insulation

2. Thermal details and lifetime

2.1 Expected lifetime

Expected lifetime						
Type	Output load	ta	30 °C	40 °C	50 °C	60 °C
	35 – 26 W	tc	60 °C	65 °C	75 °C	–
		Lifetime	> 100,000 h	> 100,000 h	55,000 h	–
LC 35/24V MTR SC PRE2	25 – 16 W	tc	–	60 °C	70 °C	80 °C
		Lifetime	–	> 100,000 h	95,000 h	55,000 h
	≤ 15 W	tc	–	60 °C	65 °C	75 °C
		Lifetime	–	> 100,000 h	> 100,000 h	65,000 h

The LED control gear is designed for a lifetime stated above under reference conditions and with a failure probability of less than 10 %.

The relation of tc to ta temperature depends also on the luminaire design.

If the measured tc temperature is approx. 5 K below tc max., ta temperature should be checked and eventually critical components (e.g. ELCAP) measured. Detailed information on request.

3. Installation / wiring

3.1 Circuit diagram

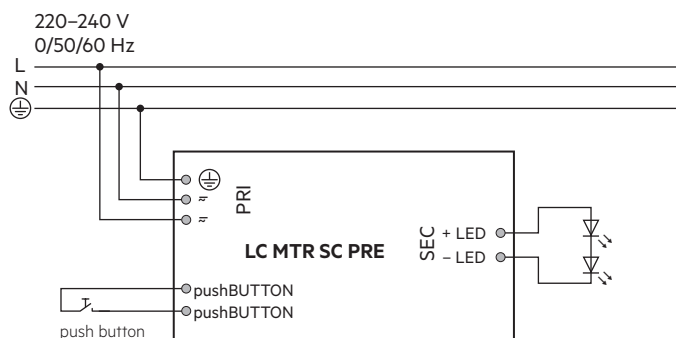

The used push button has to be insulated.

1.1 Glow wire test

according to EN 61347-1 with increased temperature of 850 °C passed.

3.2 Wiring type and cross section

For wiring use stranded wire with ferrules or solid wire from 0.2–1.5 mm². Strip 8.5–9.5 mm of insulation from the cables to ensure perfect operation of the push-wire terminals.

Use one wire for each terminal connector only.
 Use each strain relief channel for one cable only.

LED module/LED driver/supply

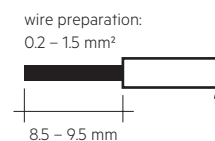

Secondary strain relief for cables with bigger cable sheath

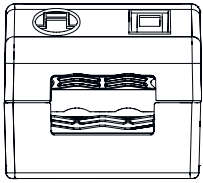

Secondary strain relief for cable with smaller cable sheath

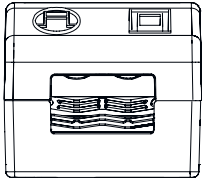

3.3 Loose wiring

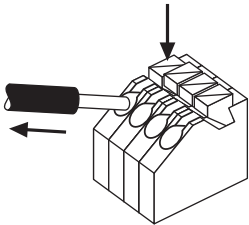

Press down the "push button" and remove the cable from front.

3.4 Fixing conditions when using as independent Driver with Clip-On

Dry, acidfree, oilfree, fatfree. It is not allowed to exceed the maximum ambient temperature (t_a) stated on the device. Minimum distances stated below are recommendations and depend on the actual luminaire. Device is not suitable for fixing in corner.

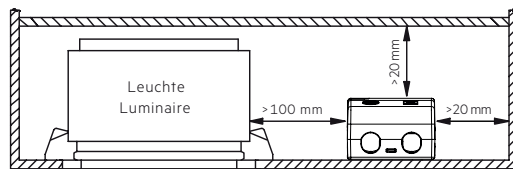

3.5 Wiring guidelines

- Run the secondary lines separately from the mains connections and lines to achieve good EMC performance.
- The max. secondary cable (LED module) length is 2 m (4 m circuit).
- For good EMC performance, keep the LED wiring as short as possible.
- To comply with the EMC regulations run the secondary wires (LED module) in parallel.
- Secondary switching is not permitted.
- The LED driver has no inverse-polarity protection on the secondary side. Wrong polarity can damage LED modules with no inverse-polarity protection.
- Wrong wiring of the LED driver can lead to malfunction or irreparable damage.
- To avoid the damage of the Driver, the wiring must be protected against short circuits to earth (sharp edged metal parts, metal cable clips, louver, etc.).

3.6 Hot plug-in

Hot plug-in is not supported due to residual output voltage of > 0 V. When connecting an LED load, restart the device to activate the LED output. This can be done via mains reset or interface (basicDIM Wireless).

3.7 Earth connection

The earth connection is conducted as protection earth (PE). The LED driver can be earthed via earth terminal. If the LED driver will be earthed, protection earth (PE) has to be used. There is no earth connection required for the functionality of the LED driver. Earth connection is recommended to improve following behaviour:

- Electromagnetic interferences (EMI)
- LED glowing at standby
- Transmission of mains transients to the LED output

In general it is recommended to earth the LED driver if the LED module is mounted on earthed luminaire parts respectively heat sinks and thereby representing a high capacity against earth.

4. Electrical values

4.1 Efficiency vs. load

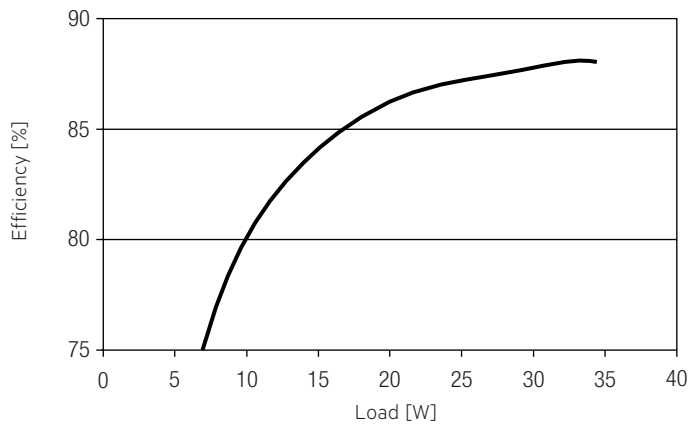

4.4 Input current vs. Load

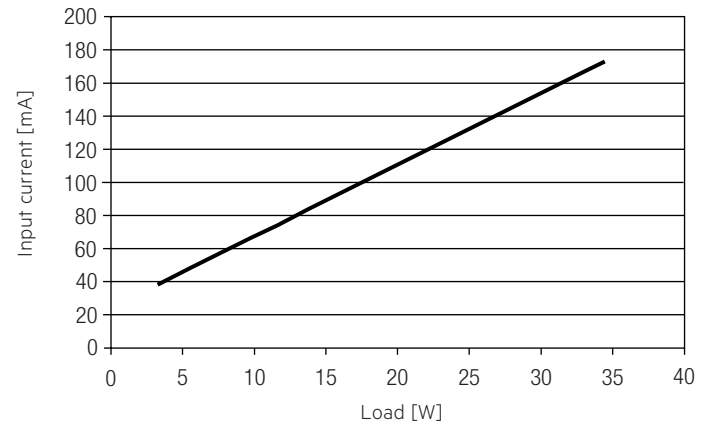

4.2 Power factor vs. Load

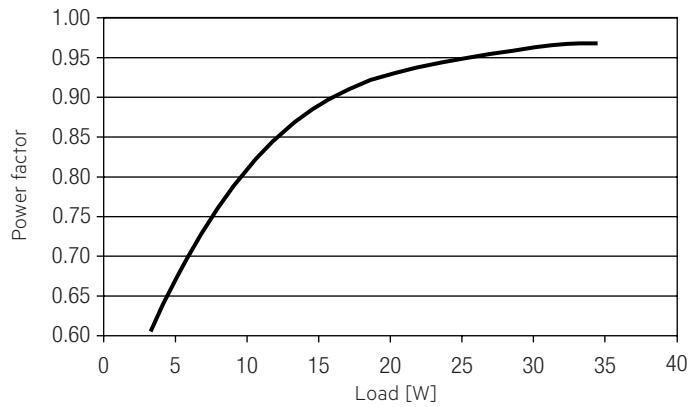

4.5 THD vs. Load

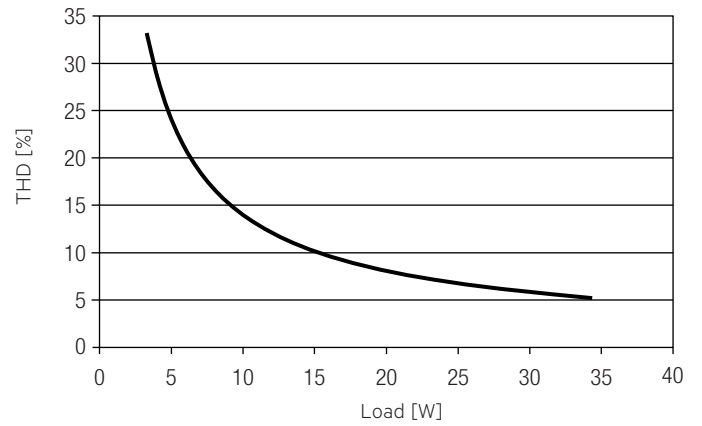

4.3 Input power vs. Load

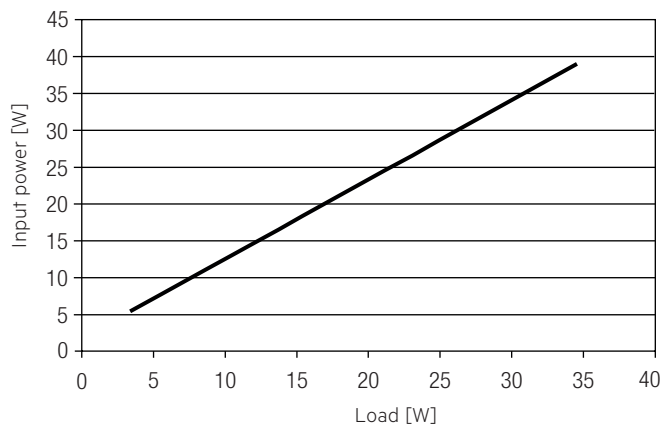

4.6 Maximum loading of automatic circuit breakers in relation to inrush current

Automatic circuit breaker type	C10	C13	C16	C20	B10	B13	B16	B20	Inrush current	
	Installation Ø	1.5 mm ²	1.5 mm ²	2.5 mm ²	4 mm ²	1.5 mm ²	1.5 mm ²	2.5 mm ²	4 mm ²	I_{max}
LC 35/24V MTR SC PRE2	27	37	47	60	16	22	28	36	21.6 A	136 µs

These are max. values calculated out of inrush current! Please consider not to exceed the maximum rated continuous current of the circuit breaker.

Calculation uses typical values from ABB series S200 as a reference.

Actual values may differ due to used circuit breaker types and installation environment.

4.7 Harmonic distortion in the mains supply (at 230 V / 50 Hz and full load) in %

	THD	3.	5.	7.	9.	11.
	LC 35/24V MTR SC PRE2	6	6	1	2	2

4.8 Dimming

Dimming range 1% to 100 %

Digital control with:

- basicDIM Wireless

4.9 Dimming characteristics

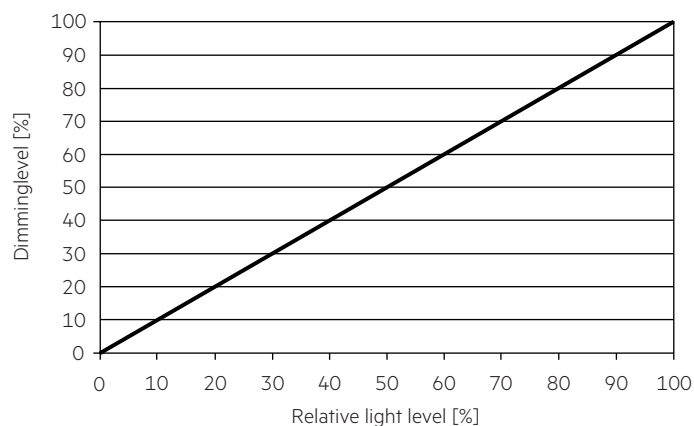

5. Interfaces / communication

5.1 Control input

A standard push button can be connected on the input terminals.

Maximum cable length of the push button is 1 meter.

This function have to be activated before using.

The control signal is not SELV. Control cable has to be installed in accordance to the requirements of low voltage installations.

Different functions depending on each module.

Profile change see handbook https://www.tridonic.com/com/en/download/technical/Documentation_Tridonic_4remote_BT_EN.pdf

5.2 QR code

The unit contains 2 QR codes that are identical. One is permanently attached to the unit and the second is to be torn off and then stuck on the luminaire or stored in the commissioning documentation.



These QR codes contain device-specific data that is required to commission the Matter luminaire. Without this, it is not possible to commission a Matter luminaire.

The QR code that is placed on the luminaire should be easy for the commissioner to reach and scan, but not visible to everyone!

If this is not possible, collect and keep the QR code stickers after commissioning.

Be sure to inform the end customer of the consequences if they are lost. With the QR code it is possible to commission the unit to a network. The QR code represents access to the network itself!

6. Functions

6.1 ready2mains – configuration

The ready2mains interface can be used to configure the main parameters of LED drivers via the mains wiring, e.g. CLO and DC level. These parameters can be adjusted via ready2mains-capable configuration software.

6.2 Short-circuit behaviour

In case of a short-circuit at the LED output the LED output is switched off. After restart of the LED driver the output will be activated again. The restart can either be done via mains reset or via software or pushBUTTON.

6.3 Overload protection

If the maximum load is exceeded by a defined internal limit, the LED driver turns off the LED output. After restart of the LED driver the output will be activated again. The restart can either be done via mains reset or via software or pushBUTTON.

6.4 Overtemperature protection

The LED driver is protected against temporary thermal overheating. If the temperature limit is exceeded the output current of the LED module(s) is reduced. The temperature protection is activated above $t_{c\ max}$. The activation temperature differs depending on the LED load. On DC operation this function is deactivated to fulfill emergency requirements.

6.5 Constant light output (CLO)

The luminous flux of a LED decreases constantly over the lifetime. The CLO function ensures that the emitted luminous flux remains stable. For that purpose the LED current will increase continuously over the LED lifetime. Via ready2mains it is possible to select a start value (in percent) and an expected lifetime. The LED driver adjusts the current afterwards automatically.

6.6 Power-up/-down fading

The power-up/-down function offers the opportunity to modify the on-/off behavior. The time for fading on or off can be adjusted in a range of 0.2 to 16 seconds. According to this value, the device dims either from 0 % up to the power-on level or from the current set dim level down to 0 %. This feature applies while operating via 4remoteBT and when switching the mains voltage on or off. By factory default no fading time is set (=0s).

6.7 Light level in DC operation

The LED driver is designed for operation on DC voltage and pulsed DC voltage.

Light output level in DC operation: programmable 1 – 100 % (EOFu = 0.13). Programming by ready2mains. In DC operation dimming mode can be activated.

The voltage-dependent input current of Driver incl. LED module is depending on the used load.

6.8 Software / programming

With appropriate software and an interface different functions can be activated and various parameters can be configured in the LED driver. To do so, a ready2mains programmer or utilityAPP is required.

7. Restore factory defaults

To restore the factory settings, the module must be switched on and off in the following sequence.

If the sequence was entered correctly, the luminaire (driver) flashes 2 times.

Stage	Duration	State
1	< 5 s	ON
2	>30 s	OFF
3	5 – 15 s	ON
4	>30 s	OFF
5	< 5 s	ON
6	>30 s	OFF
7	< 5 s	ON
8	>30 s	OFF
9	permanent	ON



8. Miscellaneous

8.1 Insulation and electric strength testing of luminaires

Electronic devices can be damaged by high voltage. This has to be considered during the routine testing of the luminaires in production.

According to IEC 60598-1 Annex Q (informative only!) or ENEC 303-Annex A, each luminaire should be submitted to an insulation test with 500 V_{DC} for 1 second. This test voltage should be connected between the interconnected phase and neutral terminals and the earth terminal. The insulation resistance must be at least 2 MΩ.

As an alternative, IEC 60598-1 Annex Q describes a test of the electrical strength with 1500 V_{AC} (or 1.414 x 1500 V_{DC}). To avoid damage to the electronic devices this test must not be conducted.

8.2 Conditions of use and storage

Humidity: 5 % up to max. 85 %, not condensed (max. 56 days/year at 85 %)

Storage temperature: -40 °C up to max. +80 °C

The devices have to be acclimatised to the specified temperature range (t_a) before they can be operated.

The LED driver is declared as inbuilt LED controlgear, meaning it is intended to be used within a luminaire enclosure.

If the product is used outside a luminaire, the installation must provide suitable protection for people and environment (e.g. in illuminated ceilings).

8.3 Placement

Matter device have an integrated antenna for easy integration. In order to maximize the range in every direction some design guidelines should be taken into consideration when mounting the device.

The antenna is located on the corner of the enclosure. It is on the top side of the internal PCB (Printed Circuit Board).

When the device is mounted on a metal plate (e.g. frame of a luminaire), it may efficiently block the radio frequency signal. In this case, a cut-out underneath the antenna may be needed for the RF signal to exit the structure. The cut-out area should be as large as possible. Also the device should be placed as far away from any vertical metal structures as possible.

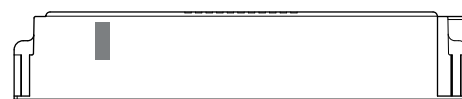

■ Antenna location

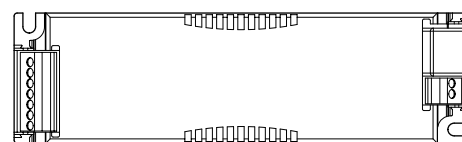

The range of the communication signal is depending on the environment e.g. luminaire, construction of the building, furnitures or humans and needs to be tested and approved in the installation.



To ensure a good radio connection, do not cover the Matter device completely with metal!

8.4 Matter certified

The device is a Matter certified device and listed in the Matter product database.

The Connectivity Standard Alliance (CSA) offers the Certification Transfer Program for re-branding/white labeling while maintaining the Certified status of those products.

To guarantee compliance while integrating these devices into luminaires, it is recommended to verify any additional requirements with the Connectivity Standards Alliance and the Transfer Program:

<https://csa-iot.org/certification/transfer-program/>

8.5 Maximum number of switching cycles

All LED driver are tested with 50,000 switching cycles.

The actually achieved number of switching cycles is significantly higher.

8.6 Additional information

Additional technical information at www.tridonic.com → Technical Data

Lifetime declarations are informative and represent no warranty claim.

No warranty if device was opened.