

# artist of light

## Specification

For LED Neon Flex Ribbon

C-FR-F21B-AC230



**CLEAR** Lighting<sup>®</sup>

# Table of Contents

Introduction	03
1. Specifications & Parameters	04
1.1 Dimensions of Light	
1.2 Technical Parameters	
1.3 Optical Parameters	
2. Functions & Features	05
2.1 Product Features	
2.2 Minimum Bend Diameter	
3. Types of Connector	05
3.1 Injection-Moulded Connector	
4. Mounting Profile	09
4.1 Standard Aluminum Profile	
4.2 Plastic Profile	
4.3 Self-locking Aluminum Profile	
5. Packaging	10
5.1 White Box Packaging	
5.2 Reel Packaging	
6. Appendix	11
6.1 Product Naming Convention	
6.2 Third-Party Test Report	
6.3 Reliability Test of Light	
6.4 Certificate	
6.5 Figures of Typical Characteristics	
6.6 Correlated Color Temperature	
6.7 (X,Y) Chromaticity Diagram	
6.8 Wavelength of Color Light	

# Introduction

C-FR-F21B, AC230V input, is a member of the Artist of Light series with smooth domed profile that allows various monochromatic lighting solutions and produces superior homogenized illumination along its elongated running length.

Built-in protection circuit design which means each two LEDs as a unit is protected, one unit failure has no effect on other units working and the whole light can keep constant lighting.

C-FR-F21B high voltage version is CE and RoHS compliant. Moreover, it has passed environmental resistance, optical, mechanical and electrical tests in our lab under the support of advanced experimental equipments and technology to ensure it meets the requirements of harsh environments. Also it has passed relevant tests of third party inspection authority.

Fully encapsulated in the flexible PVC chamber by utilizing consummate extrusion technology, and pre-installed with injection-molded connector and waterproof male & female connectors for absolute safety, easy for installation and applicable for indoor and outdoor various circumstances.

Applications:

1. Outdoor or Indoor Contour/Border Lighting
2. Architectural Outline/Decorative Lighting
3. Cove/Accent Lighting
4. Facade/Floor Lighting
5. Signage/Stage Lighting

# 1. Specifications & Parameters

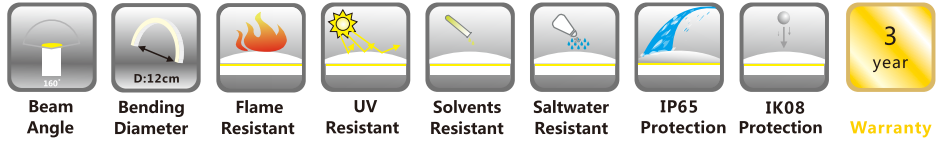

## 1.1 Dimensions of Light

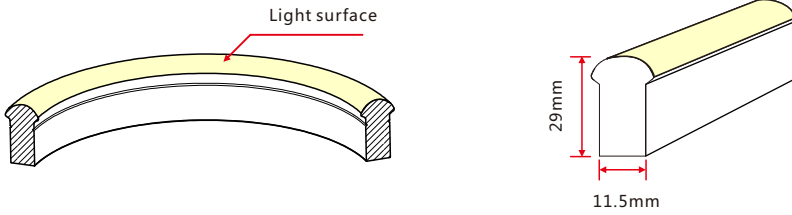

Note: Unless otherwise stated, the tolerance of the light is  $\pm 0.2\text{mm}$ .

## 1.2 Technical Parameters

Technical Parameters	
Article No.	C-FR-F21B-AC230
Color	Red/Amber/Warm White/White/Green/Blue
Working Voltage	AC 230V
Rated Power/mtr	12W
LED Qty/mtr	72LEDs
LED Distance	13.89mm
Min. Cutting Unit	72LEDs(1unit)
Min. Cutting Length	1M(1unit)
Continuous Length	80M
Weight/m	490g
Storing Temp.	-20~60°C
Working Temp.	-20~25°C
Operating Temp.	0~45°C
IP Rating	IP65



## 1.3 Optical Parameters

Photometric Data					
Article No.	C-FR-F21B-AC320				
LED Type	SMD				
Beam angle	160°				
Color	Wavelength	Lumen/m	Color	CCT	Lumen/m
Red	620-630nm	>120lm	2400K	2400±125K	>220lm
Green	520-530nm	>150lm	2700K	2725±145K	>220lm
Blue	465-475nm	>26lm	3000K	3045±175K	>220lm
Amber	585-595nm	>120lm	3500K	3465±245K	>260lm
			4000K	3985±275K	>260lm
			4500K	4503±243K	>260lm
			5000K	5028±283K	>260lm
			5700K	5660±355K	>260lm

Candle Power Distribution

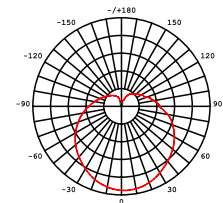

Illuminance Characteristics

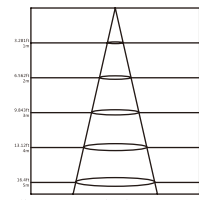

## 2. Functions & Features

### 2.1 Product Features

1. High quality and high brightness SMD LED chip.
2. Protection Circuit: Each Two LEDs Protected.
3. Variety of monochromatic lights for option including Red, Green, Blue, Amber and White light(2400K to 5700K).
4. UV & flame resistant construction(PVC).
5. Domed profile for large viewing angle(270°).
6. High color consistency&smooth illumination with no light dots.
7. Flexible with 120mm minimum bending diameter.
8. High IP rating(IP65).
- 9.The product IP rate is ultimately in line with properly applied IP rated connectors.
10. Continuous length up to 80m by powering one end.
11. Environmentally friendly & energy efficient.
12. Automated production, high reliability & long warranty.
13. 5 years life span (Do not continuously operate over 8 hours per day).

### 2.2 Minimum Bend Diameter

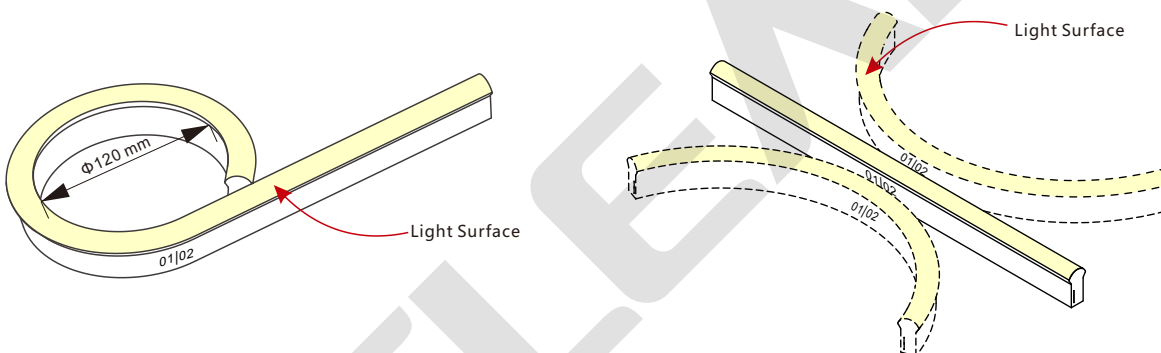

The light can only be bent laterally (opposite bend along to light surface).

Do not bend smaller than allowed minimum bend diameter.

## 3. Types of Connector

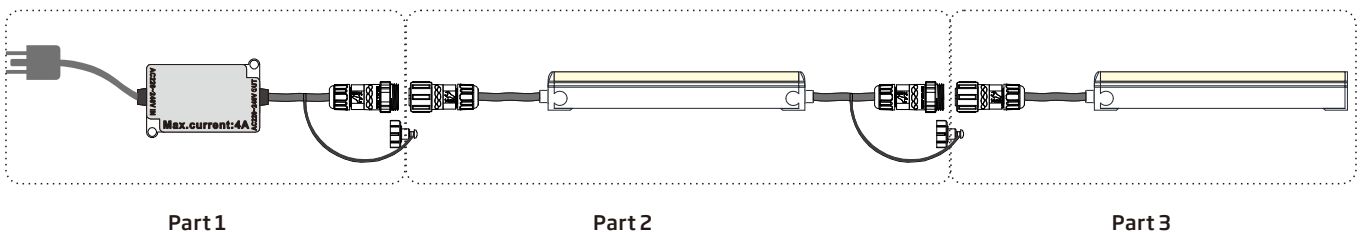

## Part 1



### Power line

1. Power line with the fuse box and the waterproof female connector (female connector is for the junction with the input end of the light), fuse box is with short circuit protection. Waterproof connector is IP65.
2. The standard for the power line can be changed to meet different requirement of different regions.

## Part 2



### Extension

1. With injection-moulded connectors on both ends, it can be used for light extension.
2. One end installed with male connector and another end installed with female connector.

Injection-moulded Front Connector (top end)

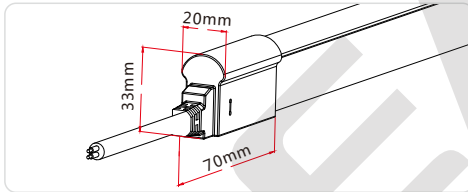
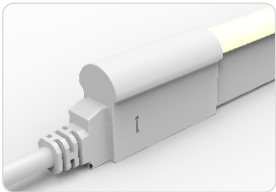

Female Connector



Male Connector



## Part 3



### Power connector & terminal

1. Power from one end with injection-moulded sealed front connector and end cap.
2. Waterproof male connector pre-installed on the cable at the position of around 0.3m (0.5m, 1m, 3m etc. for option), very convenient to be connected to the power line, easy installation.

Injection-moulded Front Connector (top end)

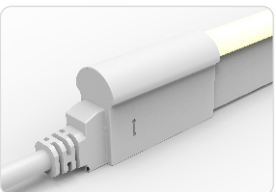

Female Connector



Injection-moulded End Cap

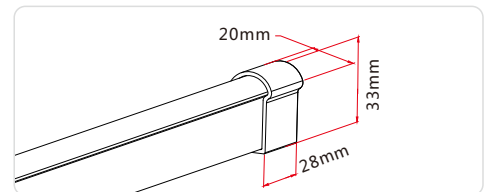
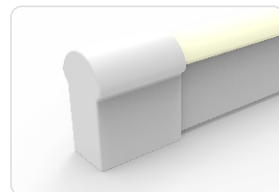

# 4. Mounting Profile

## 4.1 Standard Aluminum Profile

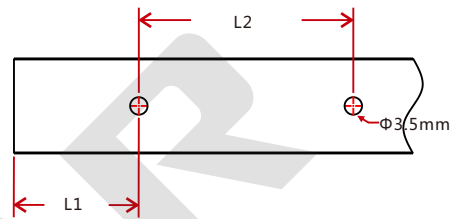
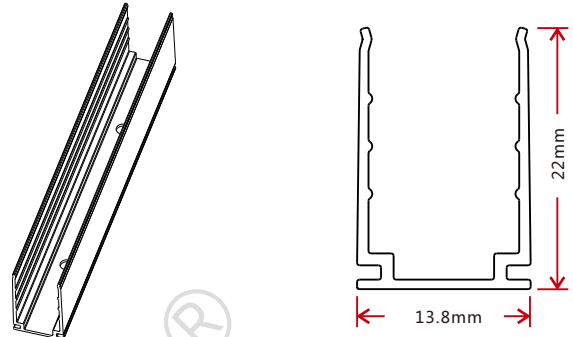
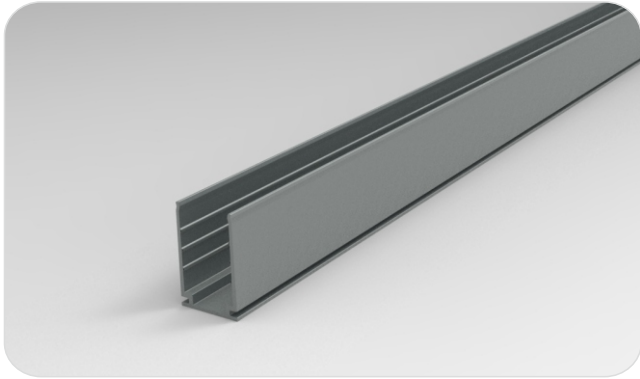

Model	W*H(mm)	Standard Length ( L:mm)	L1 (mm)	L2 (mm)	Screw Hole (Φ:mm)	Hole Number	For Product
F21-A/PL	13.8*22	30	15	/	Φ3.5	1	F11, F15, F21
		50	25	/	Φ3.5	1	F11, F15, F21
		500	50	200	Φ3.5	3	F11, F15, F21
		1000	100	200	Φ3.5	5	F11, F15, F21
		2000	100	200	Φ3.5	10	F11, F15, F21

## 4.2 Plastic Profile

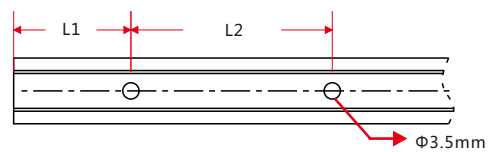
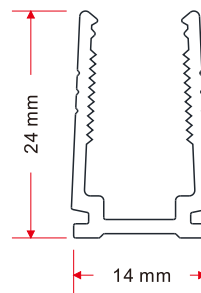
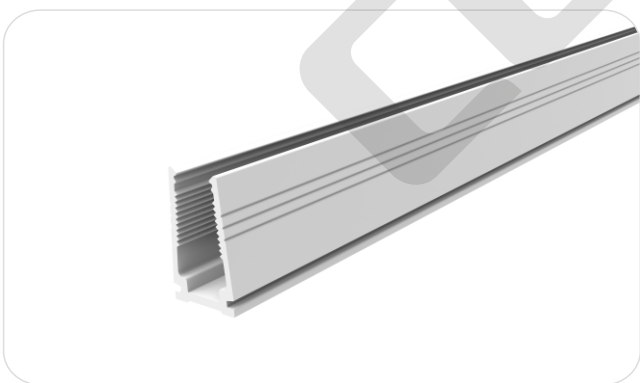

Model	W*H(mm)	Standard Length ( L:mm)	L1 (mm)	L2 (mm)	Screw Hole (Φ:mm)	Hole Number	For Product
F21-PC/PL	14*24	300	50	200	Φ3.5	2	F11, F15, F21
		500	50	200	Φ3.5	3	F11, F15, F21
		1000	100	200	Φ3.5	5	F11, F15, F21
		2000	100	200	Φ3.5	10	F11, F15, F21

### 4.3 Self-locking Aluminum Profile (Using with the Clip)

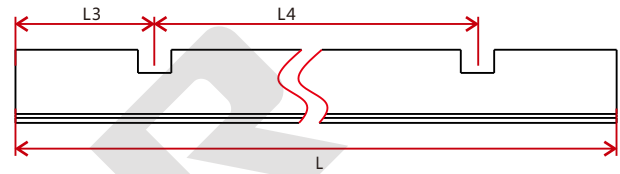
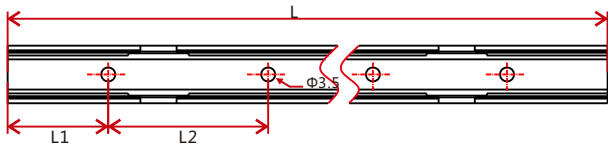
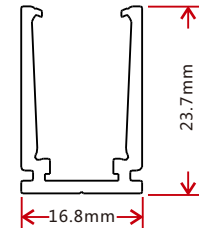
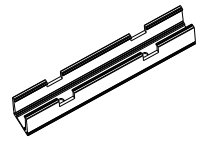
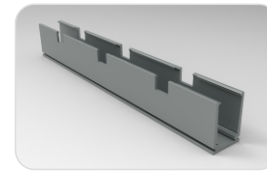
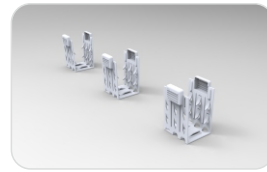
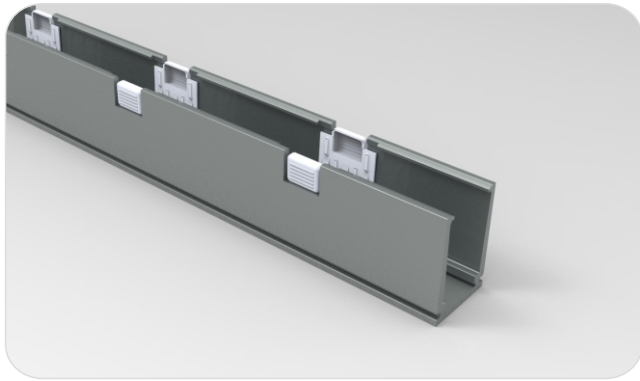

Model	W*H(mm)	Standard Length(L : mm)	L1(mm)	L2(mm)	L3(mm)	L4(mm)	Hole Screw(Φmm)	Hole Number	Clip Number
F21-SLA/PL 16.8*23.7	35		17.5	/	17.5	/	Φ3.5	1	1
	50		25	/	25	/	Φ3.5	1	1
	500		100	300	150	200	Φ3.5	2	2
	1000		100	200	150	350	Φ3.5	5	3
	2000		100	200	125	350	Φ3.5	10	6

## 5. Packaging

### 5.1 White Box Packaging

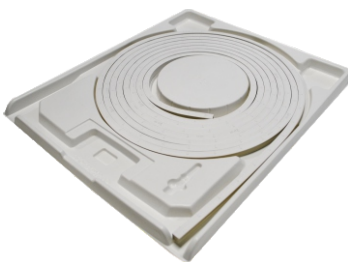

Plastic Plate

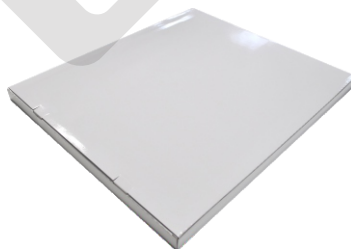

White Box



Carton



### Packaging Detail

Light Length	White Box Dimension (cm)	Carton Dimension (cm)	Numbers of White Box	Carton Weight (kg)
5m	39*5.2*50	52*41*28	5	14
10m	51*5.2*62	64*53*28	5	26
10m	51*5.2*62	64*53*17.5	3	16
20m	68*5.2*79	81*70*12.5	2	22



## 5.2 Reel Packaging



### Packaging Detail

Light Length	Reel Dimension (cm)	Carton Dimension (cm)	Numbers of Reel	Carton Weight (kg)
40m	Φ36*28	37*37*31.5	1	22KG
50m	Φ36*32	37*37*35.5	1	27KG

## 6. Appendix

### 6.1 Product Naming Convention

**C-FR-XXX(-)X-XX-XXX-XX-XXX**



For Example: C-FR-F21B-AC230-2700-WM-72

### 6.2 Third-Party Test Report

Testing Item	Testing Organization	Report Number
RoHS	SGS	CANECI202163502 A01
Flame retardant	TUV SUD	68.140.13.068.01
IK08	TUV SUD	68.140.12.171.01
Temperature risen	UL	UL file E360029-Test Record-1 Datasheet
UV: Light	AOV	A002R130308065—1R01
UV: PVC	AOV	A002R130308065—2R01

>>Note: The testing reports and certificates are available from the related official website.

### 6.3 Reliability Test of Light

Testing Item	Classification	Reference Criterion	Testing Condition/Method	Result
IP Rating Test	IP65	IEC60529	/	Pass
Environmental Test	High Temperature Storing	IEC 68—2—2	60°C	Pass
	High Temperature and Humidity Impact	IEC 68—2—3	70°C. 95%Rh	Pass
	Corrosion Resistance Test in Swimming Pool Water	/	/	Refer to test report
	Corrosion Resistance Test in Artificial Sea Water	/	/	Refer to test report
	Corrosion Resistance Test in Volatile Oil	/	/	Refer to test report
	Salt Spray Test	IEC 68—2—11	Spray continuously for 96 hours and the concentration of NaCl solution is 5%	Pass
	UV Test	ISO 4892—2	0.76W / m2, UVA—340nm, 65°C	Refer to test report
Optical Test	Light Spectrum	ANSI C78 · 377	/	Refer to test report
	Candela Distribution	LM 79	/	Refer to test report
Mechanical Test	Bending Test	/	Bending Diameter 12cm	>500 times
	Torsion Test	/	Twisting Angle: -180°~180°, Rotating Speed:7200°/min	>200 cycles
	Tensile Test	/	Increasing the strength gradually till PCB break	>68kg.f
Electrical Test	Insulation Resistance	IEC60598—1	/	>2MΩ
	Electrical Continuity	IEC60598—1	Weights were added on the connector for 1min	>14kg.f

> > Note: Please contact us for related test report.

### 6.4 Certificate

Certificating Type	Testing Organization	Certificate Serial Number	Report Reference
CE-EMC	TUV Rheinland	AE 50274407 0001	17037105 001
CE-LVD	TUV Rheinland	AE 50275368 0001	17036967 001

### 6.5 Figures of Typical Characteristics

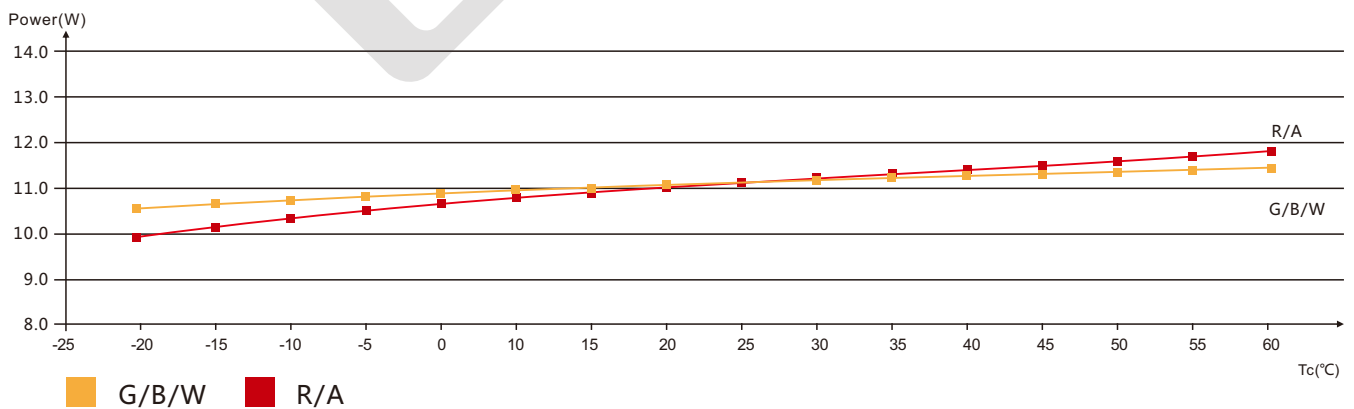

Working Temperature vs. Power

## 6.6 Correlated Color Temperature

### ANSI STANDARD

#### Nominal CCT Categories

Nominal CCT	Target CCT and tolerance(K)	Target Duv and tolerance
2700K	2725 ± 145	0.000 ± 0.006
3000K	3045 ± 175	0.000 ± 0.006
3500K	3465 ± 245	0.000 ± 0.006
4000K	3985 ± 275	0.001 ± 0.006
4500K	4503 ± 243	0.001 ± 0.006
5000K	5028 ± 283	0.002 ± 0.006
5700K	5665 ± 355	0.002 ± 0.006
6500K	6530 ± 510	0.003 ± 0.006
Flexible CCT (2700-6500K)	$T^2 + \Delta T^3$	$D_{uv}T^4 \pm 0.006$

#### Remark:

- 1). Six of the nominal CCTs correspond to those in the fluorescent lamp specification 2700K,3000K(Warm White),3500K(White),4100K(Cool White),5000K and 6500K(Daylight),respectively.
- 2). T is chosen to be at 100K steps (2800,2900 ,... ,6400K), excluding, hose eight nominal CCTs listed in Table 1.
- 3).  $\Delta T$  is given by  $\Delta T = 0.0000108 \times T^2 + 0.0262 \times T + 8$ .
- 4). Duv is given by  $D_{uv} = 57700 \times (1/T)^2 - 44.6 \times (1/T) + 0.0085$

## 6.7 (X,Y) Chromaticity Diagram

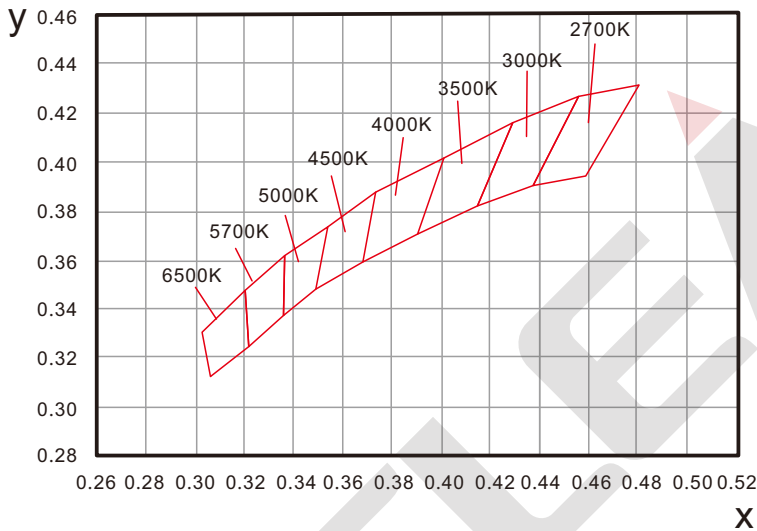

## 6.8 Wavelength of Color Light

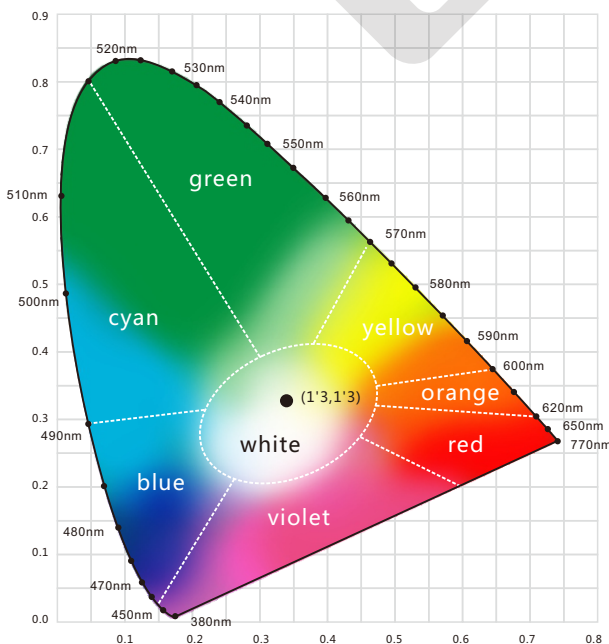

#### Light Color

- Red**  
620-630nm
- Green**  
520-530nm
- Blue**  
465-475nm