



DALI-2 Touchpanel



Datasheet Multi Control Module

Multifunctional
DALI-2 control module
with flexible
button layout

Art.Nr. 24035410-G__

Various DALI-2 Touchpanel Layouts:

Art. Nr.: G000 unprinted glasses

Art.Nr.: G01A (Dimming, 4 Scenes)

Art.Nr.: G02A (Dimming, 4 Scenes, 4 Groups)

Art. Nr.: G03A (Dimming, 4 Scenes, Tunable White)

Art. Nr.: G04A (Dimming, 4 Scenes, Tunable White, 4 Groups)

Art. Nr.: G05A (Dimming, 4 Scenes, Tunable White, 4 Groups)

Art. Nr.: G06A (Dimming, 4 Scenes, Colour RGB)

Art. Nr.: G07A (Dimming, 4 Scenes, Colour RGB, 4 Groups)

Art. Nr.: G08A (Dimming, Ceiling Fan, Blinds, 2 Groups, Tunable White, 4 Scenes)

Art. Nr.: G09A (Dimming, 4 Scenes, Colour and White RGBW)

Overview:

https://www.lunatone.com/wp-content/uploads/2020/11/DALI-2-Touchpanel-Layouts_EN.pdf

DALI-2 Touchpanel Multifunctional Control Module

Overview

- multifunctional control module for DALI and DALI-2 systems
- multi-master capable: Several modules can be installed within a DALI circuit and / or a DALI group.
- capacitive touch interface
- up to 16 configurable keys
- standard layouts and factory settings for easy installation without configuration
- flexible layout - individual design - layout exchange on site. Additional glass inserts with different prints available as accessories.
- easy configuration via Lunatone DALI USB interface and DALI-Cockpit Software Tool
- touch interface material: glass
- plastic frame (RAL 9016) aluminium frame and customer-specific frame colours upon request
- integrated DALI-2 application controller
- application controller: direct control of DALI devices
- in addition to the standard DALI commands, the application controller also supports DALI DT8 TC and RGB (W) control as well as macros
- Instance-mode: Easy integration through 16 DALI-2 pushbutton instances and 5 DALI-2 analogue instances (slider)
- easy installation on a flush-mounted installation box
- the module is supplied by the DALI bus – no additional power supply necessary
- version with integrated DALI power supply available (“-PS”)
- DALI-2 control unit according to IEC62386-103



Specification, Characteristics

Type	DALI-2 Touchpanel
article number	24035410
GTIN	9010342013089
DALI-Interface, power supply: DA, DA	
output type	DALI, DALI-2, Multimaster
terminal markings	DA, DA
voltage range	9,5V ... 22,5Vdc according to IEC62386
typical current consumption DALI (16,5V)	2 mA

DALI addresses	0
DALI-2 addresses	1

Insulation data:

impulse voltage category	II
pollution degree	2
rated insulation voltage	250V
insulation DALI / mains	reinforced isolation
insulation test voltage DALI / mains	3000Vac

environmental conditions:

storing and transportation temperature	-20°C ... +75°C
operational ambient temperature	-20°C ... +45°C
rel. humidity, not condensing	15% ... 90%

general data:

dimensions (l x w x h)	87,7mm x 87,7mm x 16,5mm
mounting	back box installation
material	touch-interface: glass, frame: plastic
expected life time	100.000h
Protection class	II (when used/installed as intended)
protection degree housing	IP40
protection degree terminals	IP20
Operating modes	Application Controller, DALI-2 Instance mode

terminals:

connection type	spring terminal connectors
wire size: solid core	0,5 ... 1,5 mm ² (AWG20 ... AWG16)
wire size: fine wired	0,5 ... 1,5 mm ² (AWG20 ...AWG16)
wire size: using wire end ferrule	0,25 ... 1 mm ²
stripping length	8,5 ... 9,5 mm / 0,33 ... 0,37 inch
tightening/ release of wire	push mechanism

standards:

DALI	IEC62386-101:2014 IEC62386-103:2014
EMV	EN 61547 EN 50015 / IEC CISPR15
safety	EN 61347-2-11 EN 61347-1
Markings	DALI-2, CE

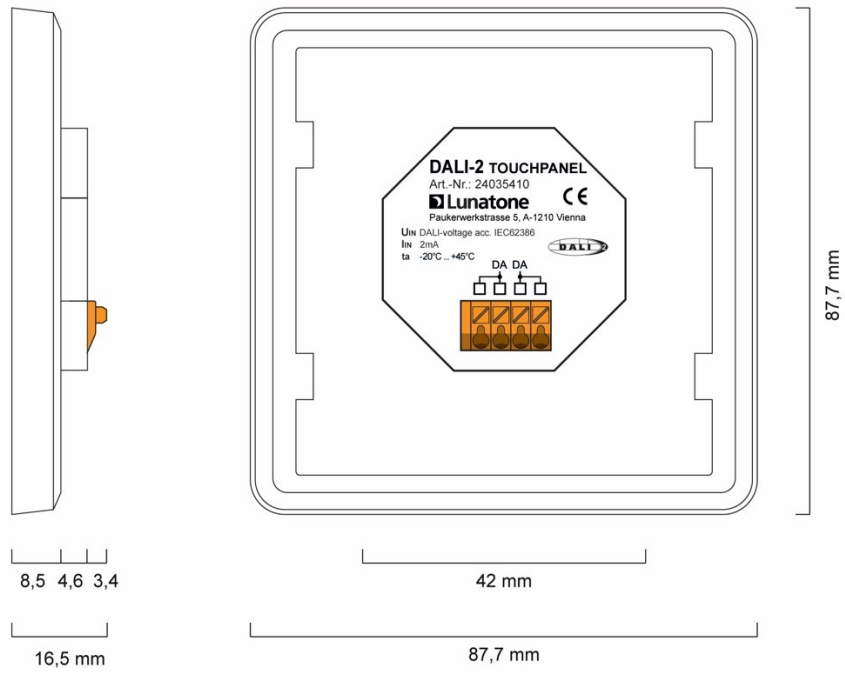

Fig.1. dimensions

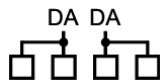

Fig.2. connection plan

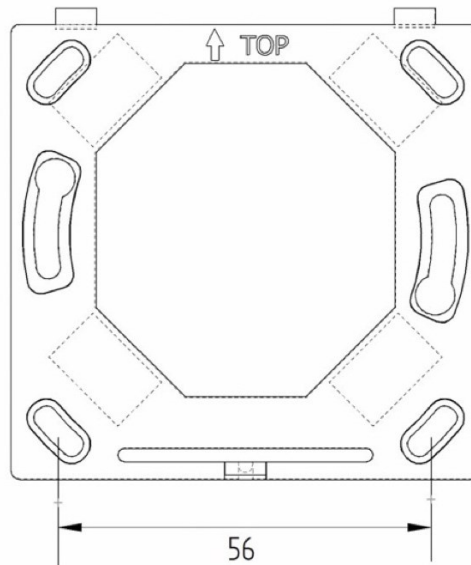

Fig.3. mounting plate

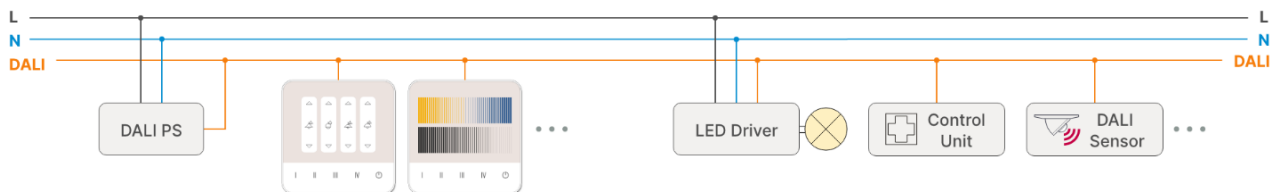

Fig.4. DALI-2 Touchpanel typical application

Specification, Characteristics – DALI-2 Touchpanel PS: Version with integrated Bus Power Supply

Version with integrated bus power supply (70mA). If not stated otherwise in the table below all information for standard version applies – all DALI-2 Touchpanel versions are available with integrated power supply 70mA.

type	DALI-2 Touchpanel-PS
article number	24035410-PS
input L,N	
input type	supply, mains-voltage
markings	N, L
input voltage range	230V AC
max. input supply current	17 mA
Input supply frequency	50Hz / 60Hz
power consumption max.	2W
start-up time	<250ms
output DA+, DA-	
output type	DALI
markings	DA-, DA+
output voltage range	12Vdc.... 20,5 Vdc
guaranteed DALI supply current	70mA
max. DALI supply current	80mA
Open circuit proof	yes
Short circuit proof	yes
insulation data	
Impulse voltage category	II
Pollution degree	2
Rated insulation voltage	250V
Rated impulse withstanding voltage	4 kV
Insulation DALI / mains	reinforced isolation
Insulation test voltage DALI /mains	3000V a.c.
general data:	
dimensions	88mm x 88mm x 39mm

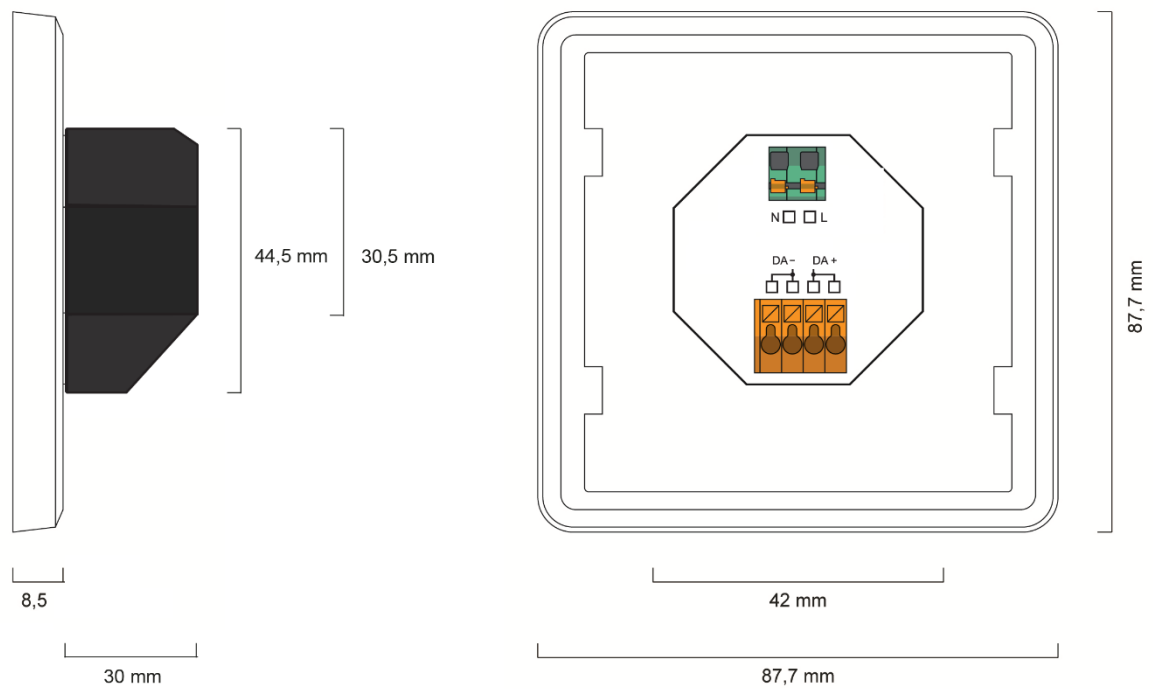

Fig.5. dimensions DALI-2 Touchpanel PS

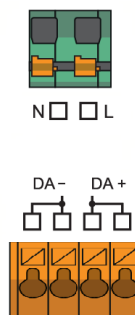
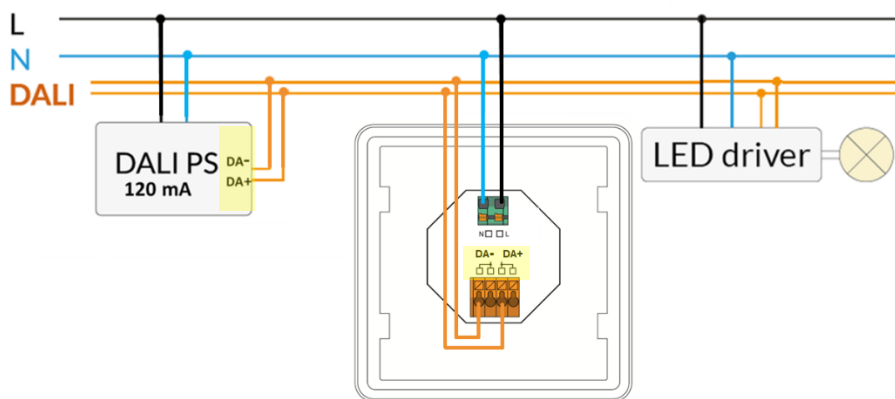

Fig.6. connection plan



If **2 bus power supplies** are on the same DALI bus: connect with the same **polarity** (DA+, DA-)! - max total supply current on the bus: **250mA!**

Fig.7. installation example DALI-2 Touchpanel PS with an additional DALI PS on the DALI bus

Installation

- The DALI-2 Touchpanel is directly connected and supplied by the DALI bus. A DALI bus power supply (e.g., DALI PS) is required, no additional power supply is needed.
- **DALI-2 Touchpanel PS:** includes a DALI bus power supply (70mA). If 2 or more bus power supplies are connected on the same DALI bus, they need to be connected with the same polarity. (marked with DA+, DA-), see Figure 7, page 6.
- National regulations for setting up electrical systems must be followed.
- The DALI wiring can be realized with standard low-voltage installation material. No special cables are required.
- Only 1 wire may be connected to each terminal. When using double wire end ferrules, the connection capacity of the terminal must be considered.



It is possible to connect multiple DALI PS on a DALI line, but **the sum of all maximum supply currents must not exceed 250 mA!**

- **DALI-2 Touchpanel** (and DALI-2 Touchpanel PS with no additional DALI PS): the connection to the DALI terminals can be made regardless of polarity. The bus input is protected against overvoltage (mains voltage).
- The wiring should be carried out as a permanent installation in a dry and clean environment.
- Installation may only be carried out in a voltage-free state of the system and by qualified specialists.



Attention: The DALI-signal is not classified as SELV circuit (Safety Extra Low Voltage). Therefore, the installation regulations for low voltage apply.



The voltage drop on the DALI line must not exceed 2V at maximum length (300m) and maximum bus load (250mA).

Wall Mounting

The DALI-2 Touchpanel can be attached to an electrical socket using a mounting plate (included), see Fig.3. page 4.

First the mounting plate is attached to the electrical socket, paying attention to the orientation - Marking:  **TOP** .

Then the DALI touch panel can be hooked in from the top and fixed with the screw on the bottom.

Addressing and Configuration

- After installation, the device can already be used with the default factory settings.
- Addressing and changes to the factory settings, such as setting the effective range and functions, are possible with the Software tool DALI Cockpit (Windows PC).
- When using the DALI-Cockpit Software, the PC must be connected to the DALI bus via a suitable interface module (DALI USB, DALI 4Net, DALI SCI RS232). The DALI-2 Touchpanel is automatically recognised by the DALI Cockpit during the addressing process and listed in the device overview.
- The addressing is done according to the DALI-2 specification and the device receives a corresponding address.
- For localisation a buzzer is integrated in each DALI-2 Touchpanel. Alternatively, the allocation can also be done via the serial number of the device.

Touch Panel Layout

The DALI-2 Touchpanel is equipped with an interchangeable glass with layout print as user interface.

An overview of the Lunatone standard layouts can be found in section “Standard Layouts and Factory Settings” on page 16.

The devices are delivered with the ordered layouts. Also, customer-specific designs can be realized.

At:

<https://www.lunatone.com/en/produkt/dali-2-touchpanel/> design templates can be found.

The User Interface can be adapted to the respective needs using standard graphics software. On request, it is also possible to use a glass without print and paper inserts (size of the inserts: 86.4mm x 86.4mm).

Thanks to the interchangeable user interface, the touch panel offers customer-specific flexibility and can be adjusted to any application.

The exchange of the layout is carried out by pressing on the upper edge – pushing the frame down, away from the glass, see Fig. 8.

Additional glasses are available as accessories. Both standard and custom designs can be ordered from Lunatone.



Attention: If the position of the buttons does not match after changing the layout, the configuration also needs to be adjusted (DALI Cockpit Software).

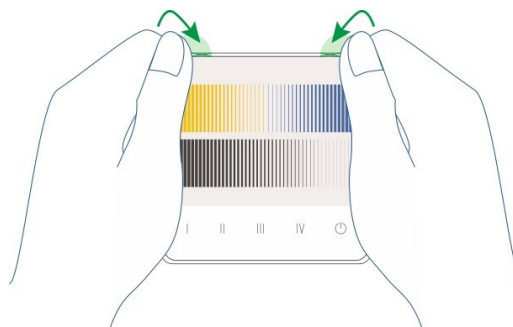

Fig. 8 pressure points to exchange the glass

Operation and Function

The DALI-2 Touchpanel is a universal module to control DALI compatible luminaries.

Each DALI-2 Touchpanel layout can implement up to 16 buttons. The function of each button can be configured individually.

On delivery the buttons are preconfigured, matching the inserted layout.

If the design is changed, the button configuration should be adapted accordingly.

As with other Lunatone control devices, the settings can be changed with the DALI Cockpit Software tool.

In the DALI Cockpit device overview existing configurations can be saved or loaded by right-clicking on the device, using "Export device settings ..." or "Import device settings ..." accordingly, see Figure 9.

All Lunatone standard layout configuration files and descriptions can be found under:

<https://www.lunatone.com/en/produkt/dali-2-touchpanel/>

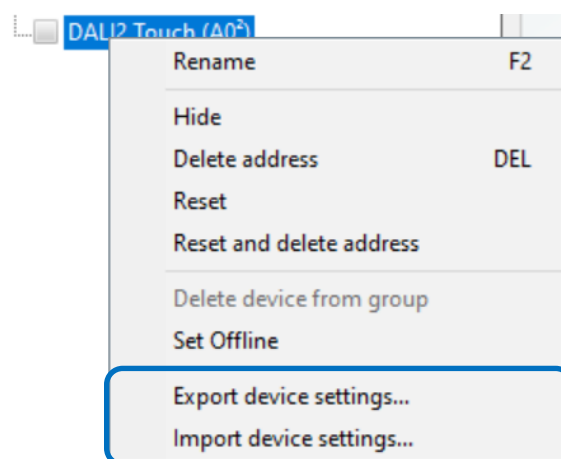

Fig.9 import or export device settings

With the DALI Cockpit Software tool, existing settings can be adjusted to fit the application e.g. number of buttons, button functions, effective range, etc. see Fig.10 and Fig.11.

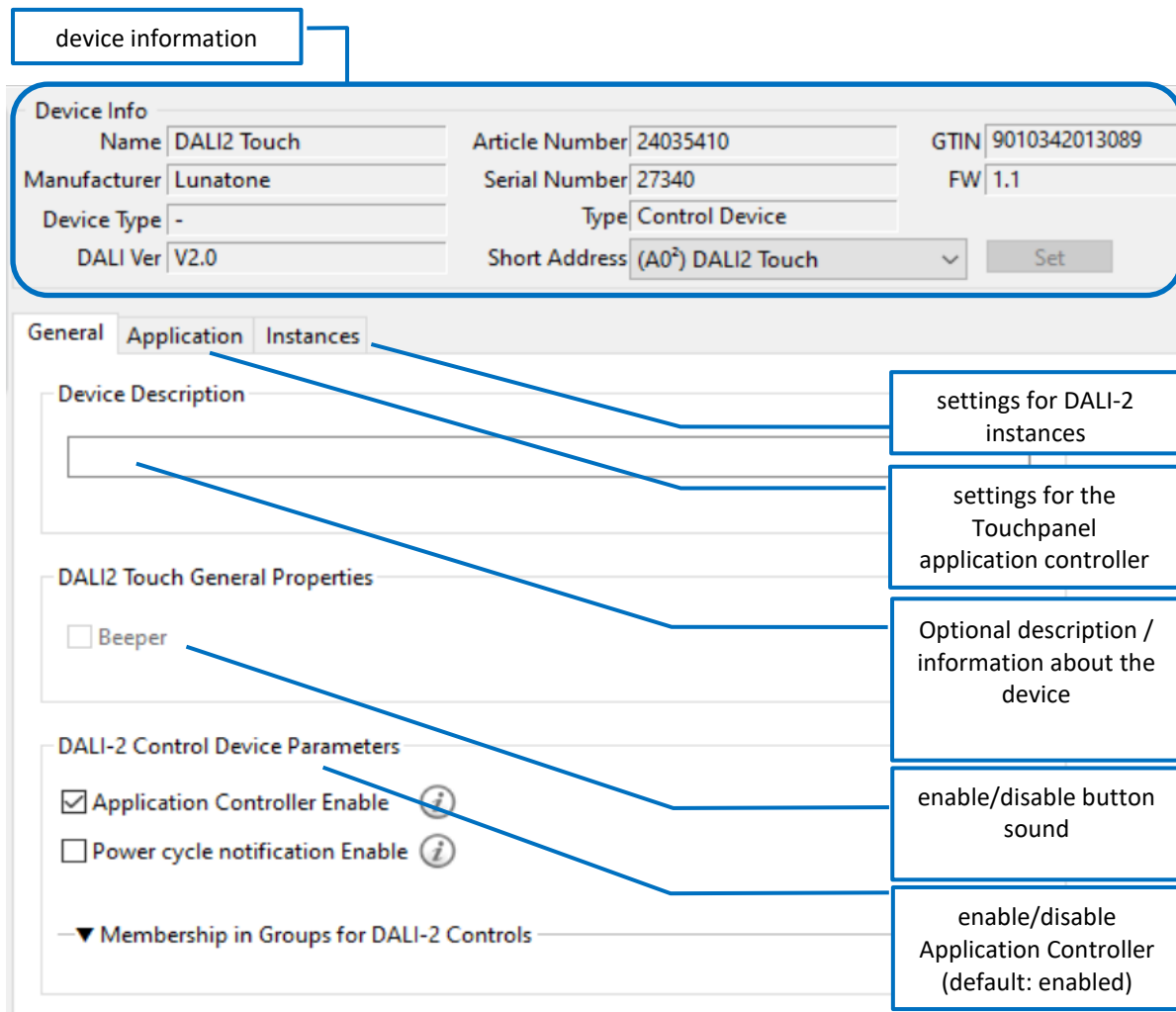

Fig.10 general settings – DALI Cockpit

It is necessary to distinguish between application controller and DALI-2 instances.

The application controller gives direct DALI control commands that are immediately executed by the DALI drivers.

The DALI-2 instances generate event messages that are interpreted and processed by higher-level control units (WAGO, Beckhoff, LUNATONE DALI-2 KNX gateway).

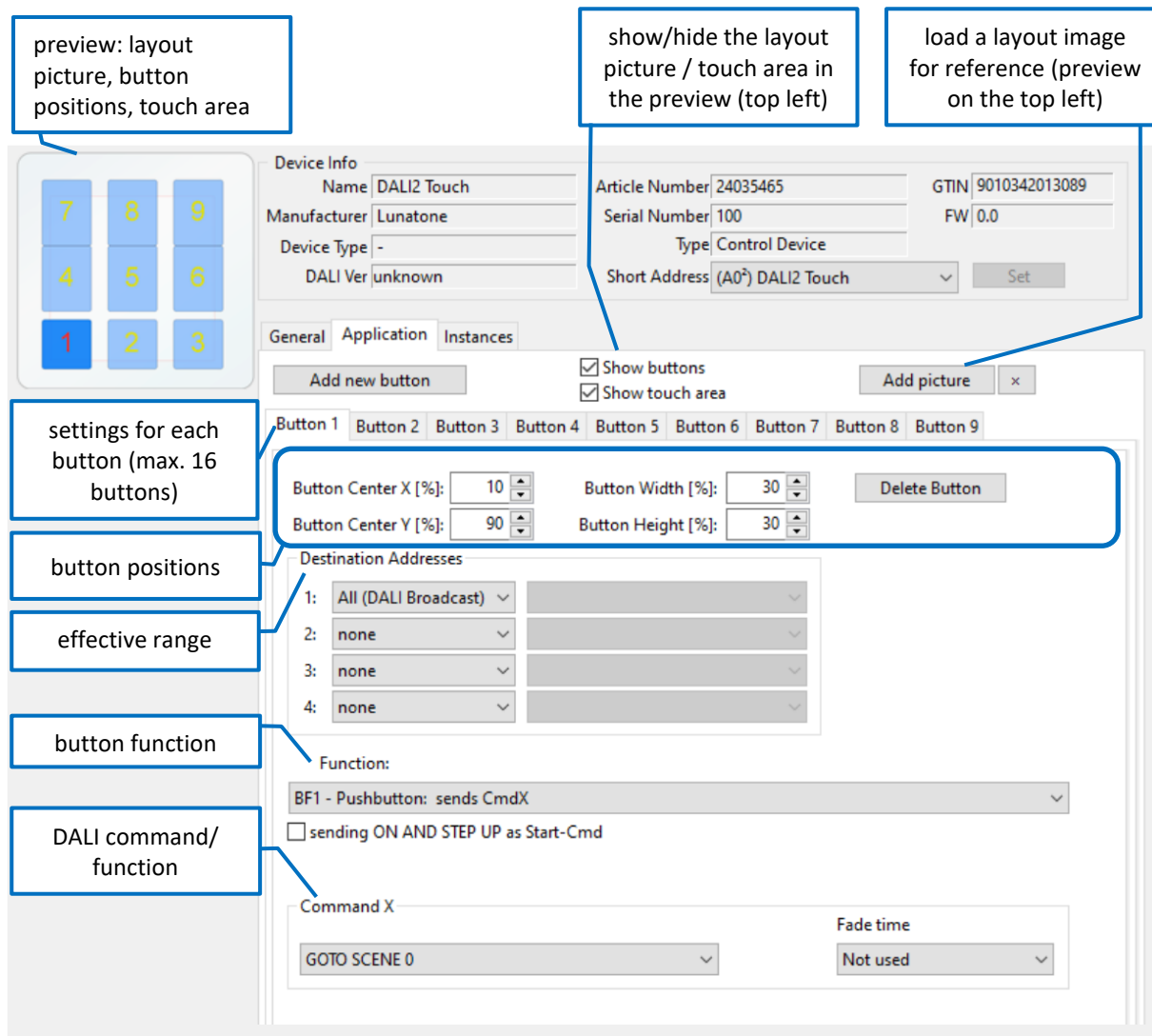

Fig.11 Application: Application Controller

Button position

To adjust the button positions, a reference picture can be added to the preview on the top left corner of the Cockpit Window (Fig.11.: "Add picture"). Supported image formats: bmp, jpg, png, gif, tif, tiff, emf.

The positions of the buttons are defined by 4 parameters:

- Button Centre X in % Button Width X in %
- Button Centre Y in % Button Height Y in %

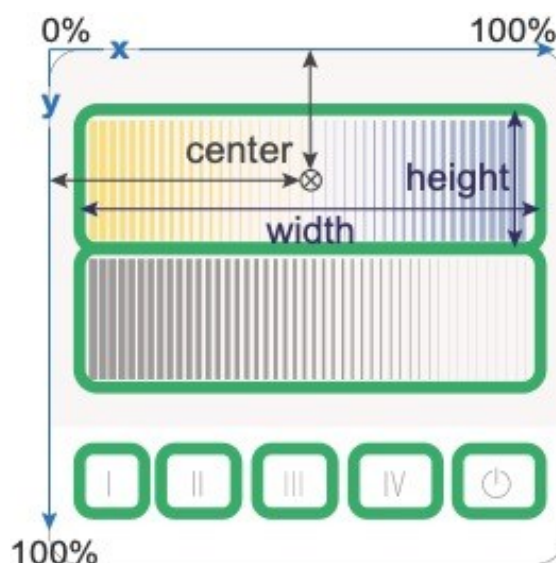

Fig.12 Button positions (indicated in green)

Destination address / effective range

In the section “destination addresses” it is possible to define which devices are affected by the button function. Possible destination addresses:

- Broadcast (an alle)
- DALI group (0 - 15)
- DALI single address (0 - 63)

Up to 4 different target addresses can be defined for each button. When the button is pressed the target addresses 1 to 4 will be processed sequentially (see Fig. 13)

The screenshot shows a configuration window titled "Destination Addresses" with four rows. Row 1: Group (Gruppe 1 (G1)). Row 2: Group (Gruppe 11 (G11)). Row 3: Single Address (A21). Row 4: Single Address (A45). Below this, the function is set to "BF1 - Pushbutton: sends CmdX" and the command is "OFF". A blue arrow points from the configuration to a log table.

Address	Command	Time
G1	OFF	12:54:04.695
G2	OFF	12:54:04.723
A21	OFF	12:54:04.749
A45	OFF	12:54:04.777

Fig.13 Example: Addressing Inputs 1-4 – sequentially processed

Button Function (BF)

Various "Button Functions" (BF) can be assigned to the individual buttons. The “Button Function” defines the behaviour of a button. A short or long press of the button can trigger different DALI commands.

A toggle function (switching between on and off) is also possible.

For the DALI-2 Touchpanel following "Button Functions" are available, Fig.14

- BF0 - no action
- BF1 - Pushbutton: sends CmdX
- BF2 - Pushbutton: CmdX on short press, CmdY on long press
- BF3 - Pushbutton: CmdX on short press, CmdY on extra long press
- BF4 - Toggle button: CmdX/CmdY toggles with every press
- BF5 - Toggle button: CmdX/CmdY depending on actual Light Level
- BF6 - Dim button: CmdX/CmdY/UP/DOWN depending on actual Light Level
- BF7 - Switch: CmdX to switch ON, CmdY to switch OFF
- BF8 - Changeover switch: CmdX/CmdY depending on actual Light Level
- BF9 - Staircase control: CmdX and after the delay CmdY
- BF10 - Pushbutton: CmdX on short press and release, CmdY on long press with repetition
- BF11 - Pushbutton with repetition: sends CmdX, repeats CmdY
- BF13 - TW DimButton: CmdX/CmdY/COOLER/WARMER
- BF16 - DAP Circle
- BF17 - Scene Circle
- BF18 - Colour temperature Circle
- BF19 - RGB Circle
- BF20 - Slider
- BF21 - Slider Tc
- BF22 - Slider RGB
- BF27 - Colour Slider RED
- BF28 - Colour Slider GREEN
- BF29 - Colour Slider BLUE

Fig.14 DALI-2 Touchpanel button functions

Key presses (short / long) are queried according to the following timing diagram and translated into internal signals (**key events**):

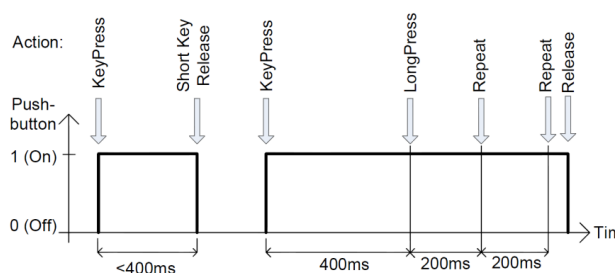



Fig.15 Key Events

The following table shows how the selected “Button Function” (lines 0 to 13) sends the commands **CmdX** and **CmdY** in connection with the “Key Events” (see Fig. 15). CmdX and CmdY refer to DALI commands.

 **Note:** The DALI commands are transmitted to all assigned target addresses.

button function number	event: press	event: short press	event: long press	event: extra-long press	event: repeat	function	typical application
0	-	-	-	-	-	-	-
1	CmdX	-	-	-	-	sends CmdX on key press	master off
2	CmdX	-	CmdY	-	-	sends CmdX on key press sends CmdY on long key press	switch to 2 different levels
3	-	CmdX	-	CmdY	-	sends CmdX on key press sends CmdY on extra-long key press	store level as scene
4	CmdX / CmdY toggle	-	-	-	-	sends alternating CmdX and CmdY on key press	toggle push button
5	CmdX / CmdY toggle	-	-	-	-	sends CmdX or CmdY on key press (depending on bus status)	changeover button
6	-	CmdX / CmdY toggle	ON AND STEPUP	-	UP / DOWN	sends CmdX or CmdY on short key press (depending on bus status) sends ON and STEPUP, if bus state is OFF before UP sends alternating UP or DOWN on repeat	push and dim
7	CmdX (CmdY on release)	-	-	-	-	sends CmdX on key press sends CmdY on key release	switch
8	CmdX / CmdY toggle (CmdY / CmdX toggle on release)	-	-	-	-	sends CmdX or CmdY on key press (depending on bus status) sends CmdY or CmdX on key release (depending on bus status)	changeover switch
9	CmdX (CmdY on delay)	-	-	-	-	sends CmdX on key press sends CmdY after a programmable delay	staircase control
10	-	CmdX	CmdY	-	CmdY	sends CmdX on short key press sends CmdY on long key press sends CmdY on repeat	push and dim
11	CmdX	-	-	-	CmdY	sends CmdX on key press sends CmdY on repeat	push and dim
13	-	CmdX / CmdY toggle	-	-	WARMER / COOLER	sends CmdX or CmdY on short key press (depending on bus status) sends alternating WARMER or COOLER on repeat	tunable white dim

Tab. 1

BF 16 – DAP Circle

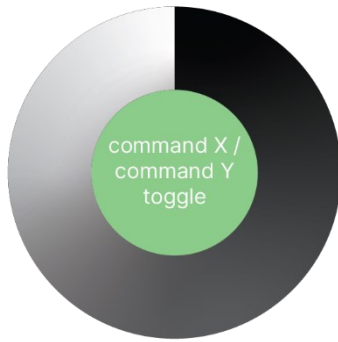

BF17 Scene Circle



BF18 Colour temperature Circle

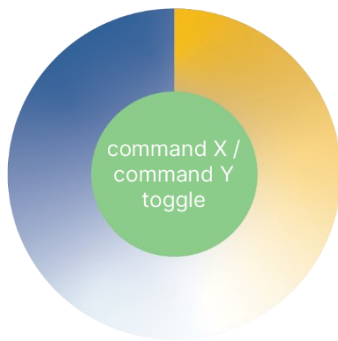

BF19 RGB Circle

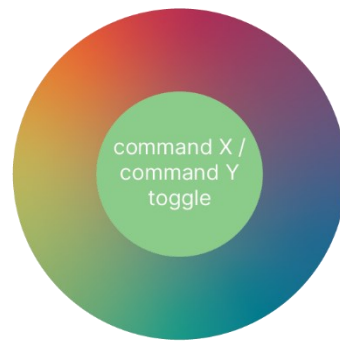

BF20 Slider

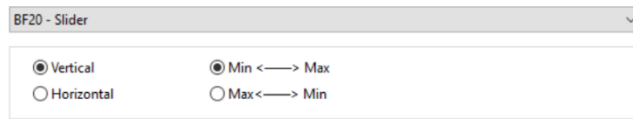
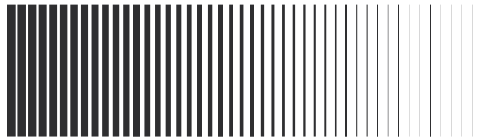

BF21 Slider Tc

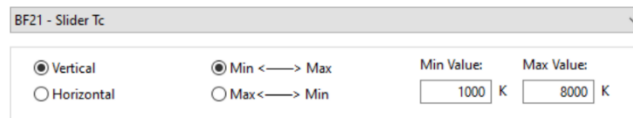
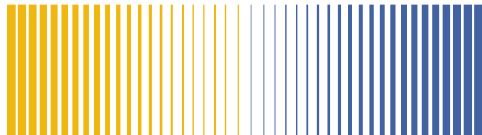

BF22 Slider RGB

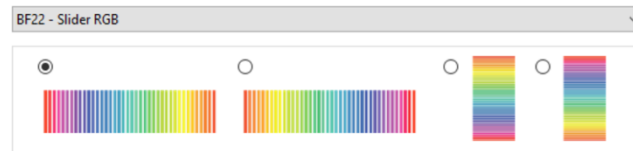
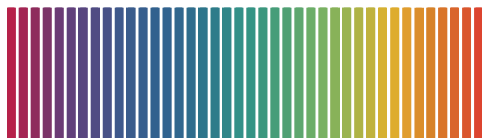

BF27 Colour Slider RED

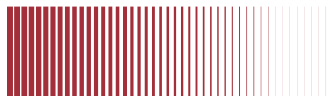

BF28 Colour Slider GREEN



BF29 Colour Slider BLUE



Commands:

The actual action (which function is triggered when pressing a button) is determined by the button function and command assigned to the button.

In most cases, an X command (CmdX) and also a Y command (CmdY) can be selected.

The following options are available:

Command number	Command name	action / function
no Nr.	DIRECT ARC POWER	direct arc power Level in %
0	OFF	off
1	UP	dim up (using fade rate)
2	DOWN	dim down (using fade rate)
3	STEP UP	increases light level by one increment
4	STEP DOWN	decreases light level by one increment
5	RECALL MAX	recalls MAX value
6	RECALL MIN	recalls MIN value
7	STEP DOWN AND OFF	decreases light level by one increment, if value at MIN switch off
8	ON AND STEP UP	increases light level by one increment, if OFF switch on
10	GOTO LAST ACTIVE LEVEL (DALI 2)	DALI-2-Cmd for switching on to the last active level (Memory-Function) (Firmware 2.0 and up)
16-31	GO TO SCENE	go to scene 0-15

Tab. 2

Depending on the selected command, additional input fields might appear for further settings:

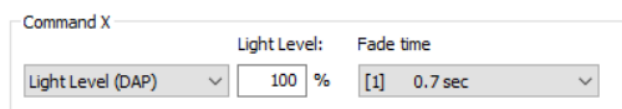

Fig. 16

Predefined macros:

Macros are predefined/ user defined command sequences that can be triggered by a single command.

The following macros are available:

Nr	Macro	Function
M1	Go Home	Light dims down to DAP 0 with predefined fade time, then fade time is set back to a programmable value
M2	Sequential Scenes	A list of the scenes can be defined; the scene is switched with each button press.
M3	Dynamic Scenes	A dynamic sequence of up to 16 scenes can be defined, including custom fade times and delays.
M4	Save actual light level as scene	When triggered the current level is saved in a scene (options: light level, RGB colour value, WAF colour value or colour temperature).
M5	User Defined Cmd-List	A user-defined macro script with up to 19 commands is executed.
M6	TC cooler	Activates the DT8 mode and sends the command "COOLER" 3 times.
M7	TC warmer	Activates the DT8 mode and sends the command "WARMER" 3 times.
M8	Send RGB +	Activates the DT8 mode and sends an ascending RGB colour table value.
M9	Send RGB -	Activates the DT8 mode and sends a descending RGB colour table value.
M10	Delayed Off	Sends a DAP level and after a delay the OFF command. DAP level and delay are user defined.

Tab. 3

DALI-2 instances

In this operating mode, no DALI control commands are sent on the bus, but DALI-2 event messages for DALI-2 compatible central control systems. General information on DALI-2 Instance mode can be found [here](#).

The DALI-2-Touchpanel supports up to 16 instances of type 1 (IEC62386-301, Input Devices – Push Button), and 5 instances of type 2 (IEC62386-301, Analogue Input Device) which are assigned to the 16 buttons and 5 sliders / circles accordingly.

The number of sliders (BF20-BF22, BF27-BF29) or circles (BF16-BF19) is therefore limited to 5 for the instance mode.

The instances are assigned to the buttons one after the other - see the example below:

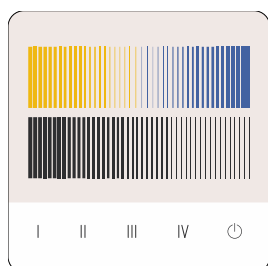

Layout



Button1	Pushbutton	BF1	Instance 0
Button2	Pushbutton	BF1	Instance 1
Button3	Pushbutton	BF1	Instance 2
Button4	Slider Tc	BF21	Instance 16
Button5	Slider	BF20	Instance 17
Button6	Pushbutton	BF1	Instance 3
Button7	Pushbutton	BF1	Instance 4

Button – Instance Assignment

DALI-2 Pushbutton Instance (instance type 1)

As defined in the standard, the following events are supported and sent on the DALI bus as INPUT NOTIFICATIONS:

Event name	Event Information	Description
Button released	00 0000 0000b	The button is released
Button pressed	00 0000 0001b	The button is pressed
Short press	00 0000 0010b	The button is pressed and released, without being pressed quickly again (in case of double press enabled), or the button is pressed and quickly released (in case double press is disabled)
Double press	00 0000 0101b	The button is pressed and released, quickly followed by another button press
Long press start	00 0000 1001b	The button is pressed without releasing it
Long press repeat	00 0000 1011b	Following a long press start condition the button is still pressed, the event occurs at regular intervals as long as the condition holds
Long press stop	00 0000 1100b	Following a long press start condition, the button is released

Button free	00 0000 1110b	The button has been stuck and is now released
Button stuck	00 0000 1111b	The button has been pressed for a very long time and is assumed stuck.

Tab.4

Further parameters of the instances 0-15 are: event filter and event timer settings (short timer, double timer, repeat timer, stuck timer), which can be configured via the DALI Cockpit Software. See Fig. 17.

Default settings for pushbutton instances:

Assigned Instance groups	None
Event Scheme	Instance addressing
Selected Event Filters	Short press, Long press start Long press repeat Long press stop Button Stuck/free
Short press timer	500ms
Double press timer	- (not used)
Repeat timer	160ms
Stuck Timer	20s

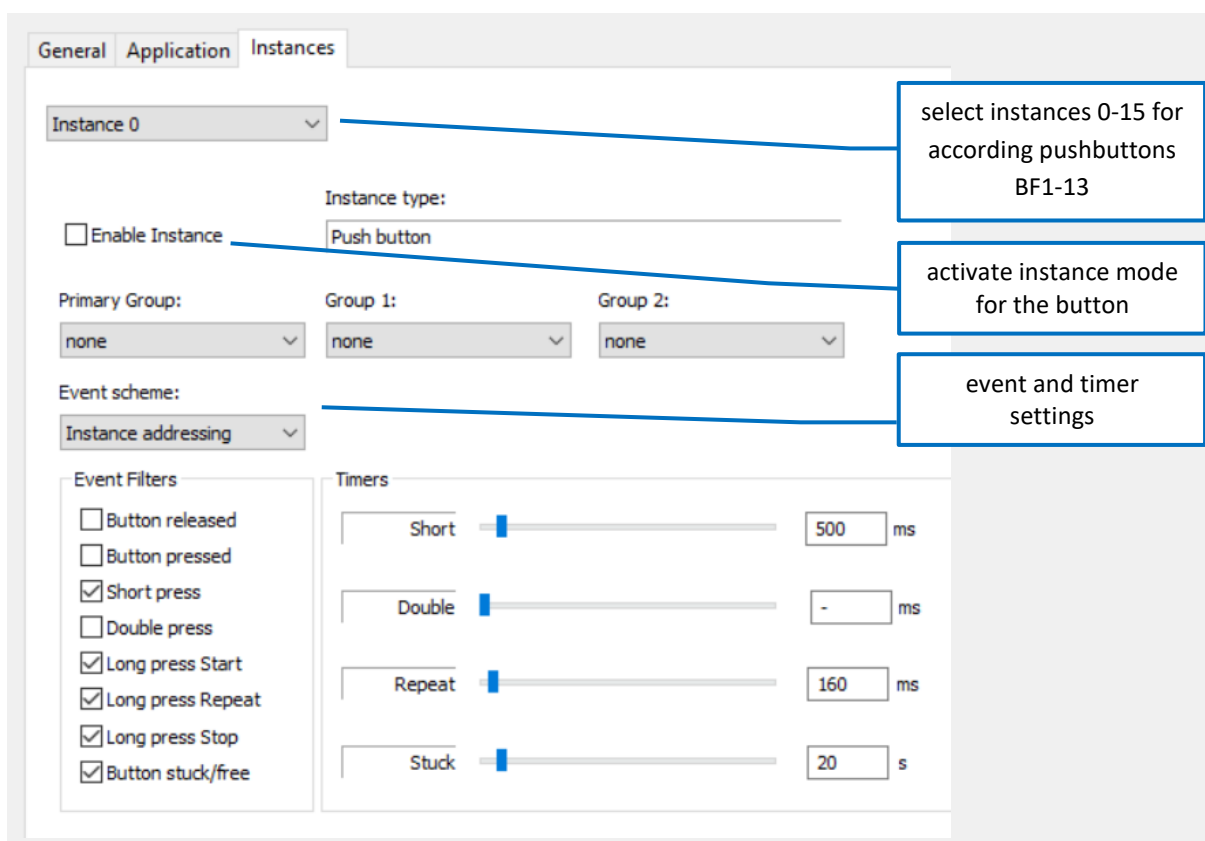

Fig.17 Instance Settings – Pushbutton Instances 0-15

DALI-2 Analog Instance (Instancetype 2)

The event input value of the analogue instance corresponds to the selected position value on the assigned slider or circle. If this value is changed, the instance generates a DALI-2 event ("INPUT NOTIFICATION").

Parameters of the analogue input device instances 16-20 are: event filter and event timer settings (report, deadtime), which can be configured via the DALI Cockpit Software.

By using the report timer, the input value is sent periodically as a DALI-2 event regardless of input value changes. (Report Timer set to 0s, means no event is sent)

The deadtime can be used to prevent the generation of an event by the instance for the set deadtime-period.

Default Settings for analog input instances:

Assigned Instance groups	None
Event Scheme	Instance addressing
Selected Event Filters	Position
Event Priority	5 (lowest)
Report timer	255s
Deadtime	12,75s

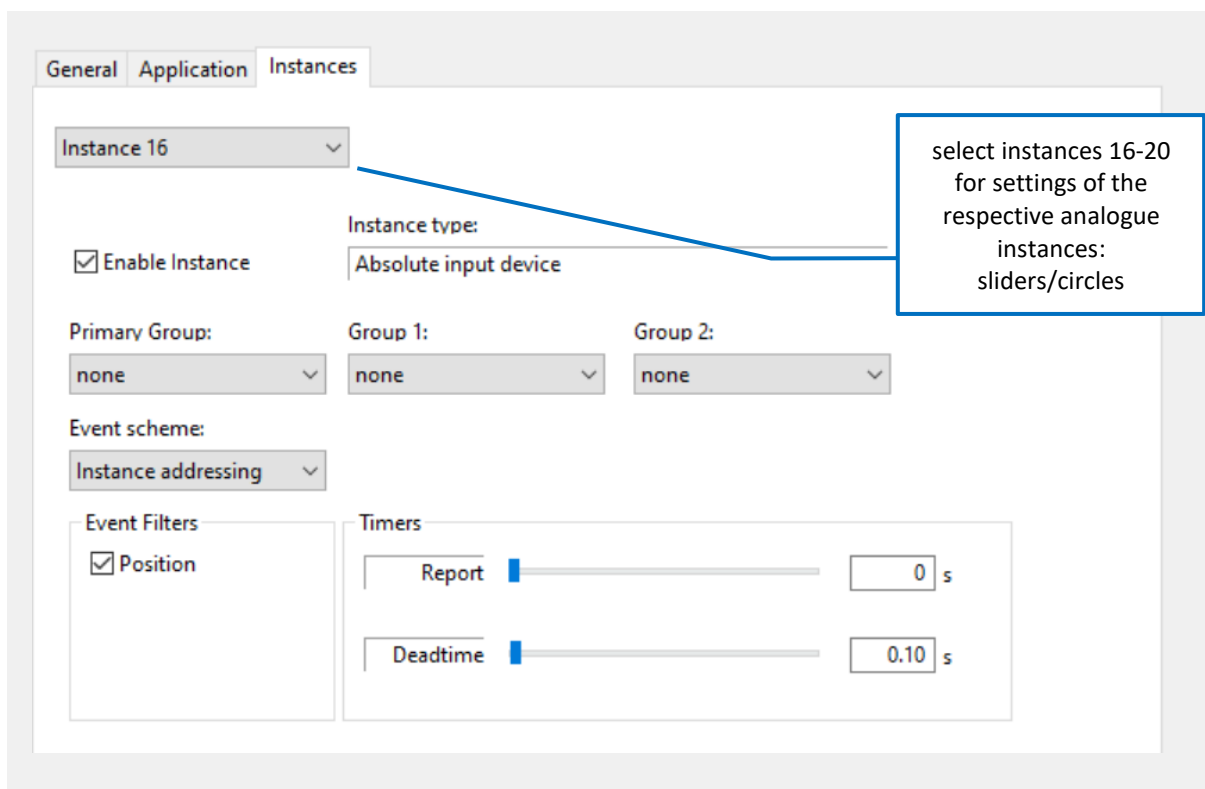
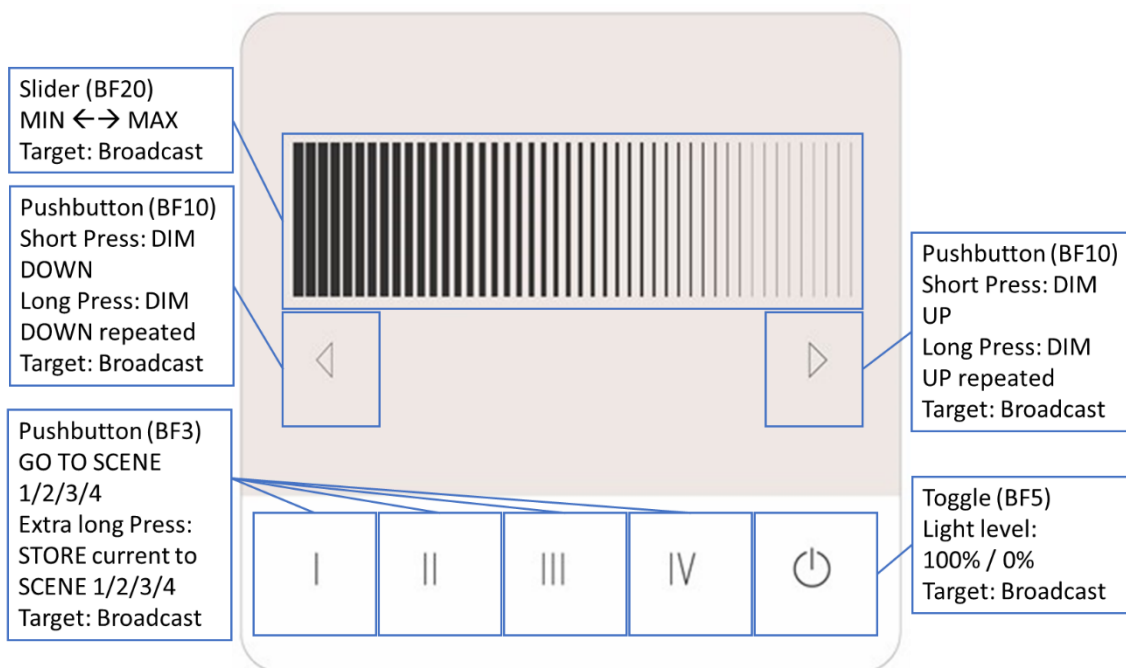
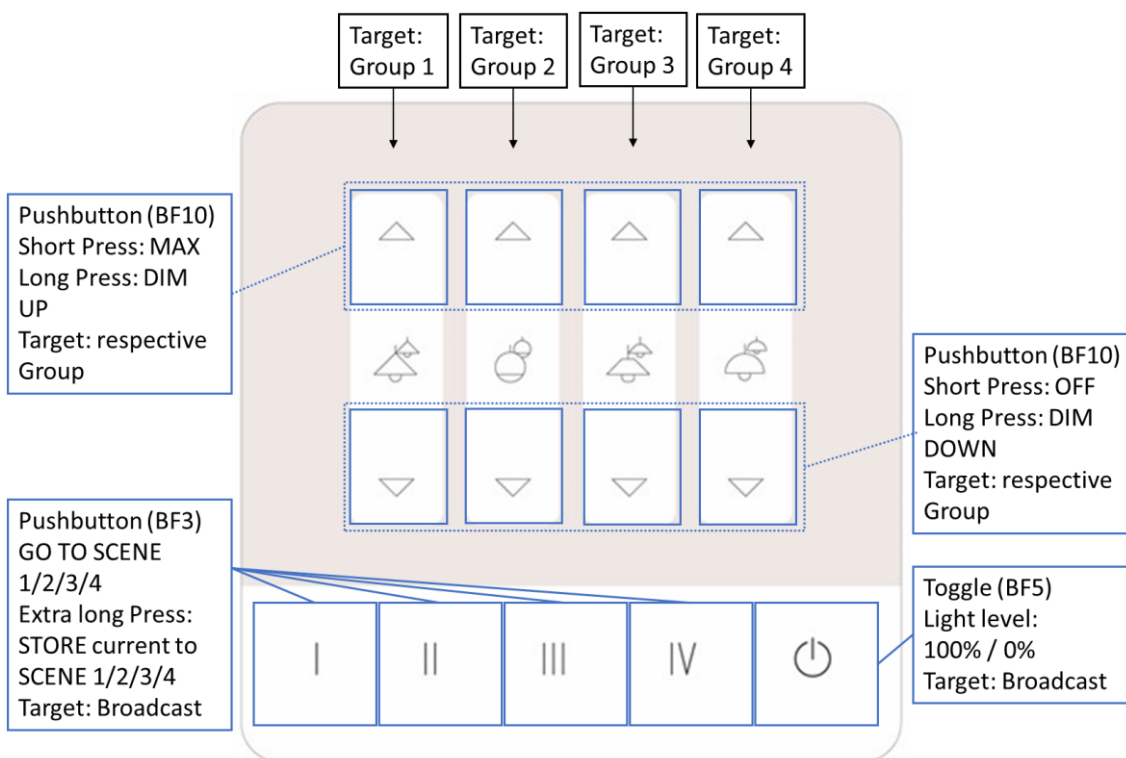

Fig.18 Instance Settings – Analogue Instances 16-20

Standard Layouts – Factory Settings



Layout Art. Nr.: G01A brightness slider & arrows for fine adjustment



Layout Art. Nr.: G02A 4 groups separately dimmable with arrows

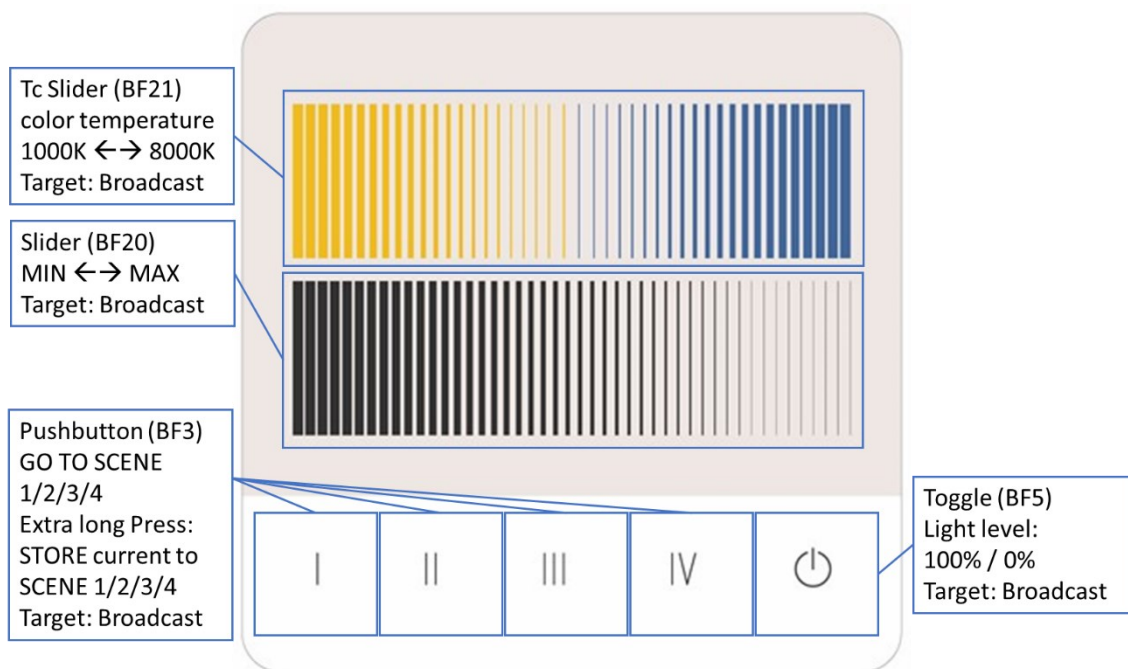

Layout Art. Nr.: G03A brightness slider & tunable white slider

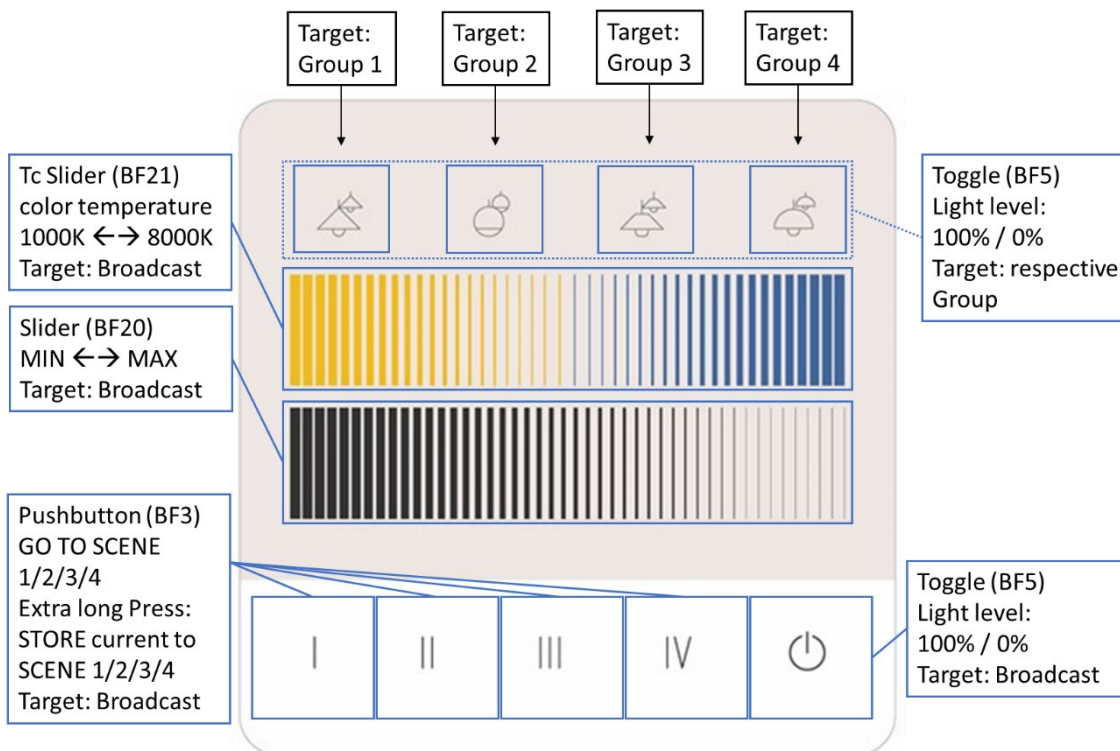

Layout Art. Nr.: G04A 4 groups on/off, brightness slider, tunable white slider

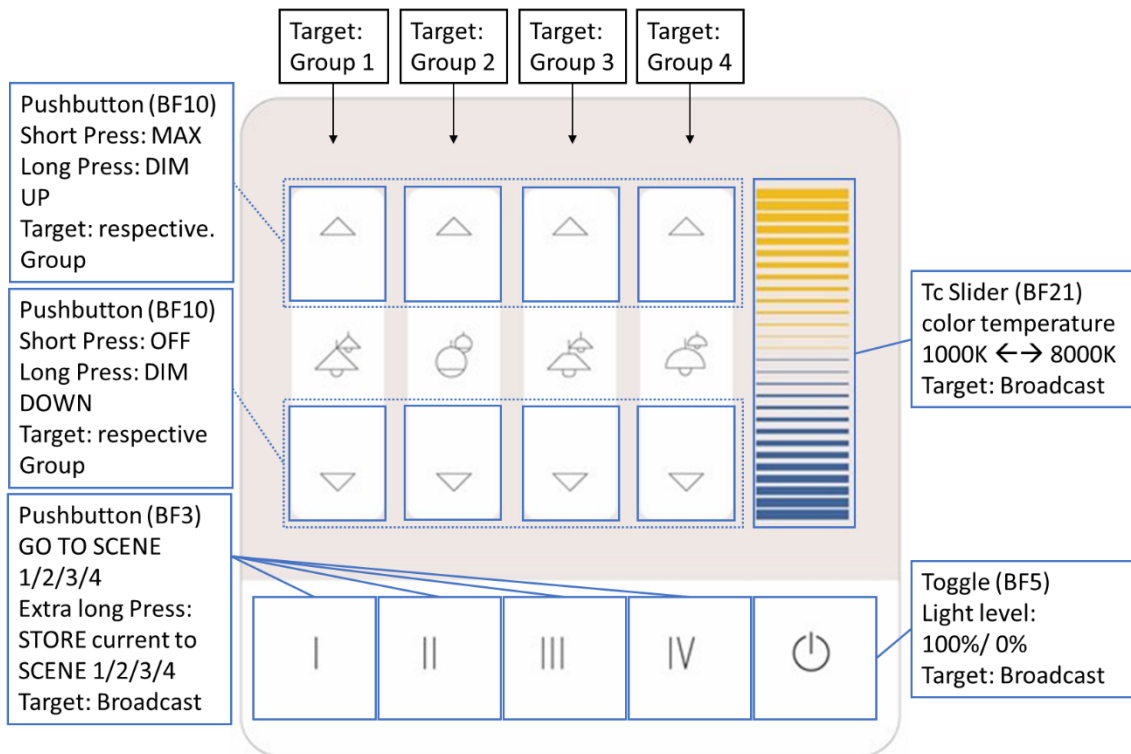

Layout Art. Nr.: G05A 4 groups separately dimmable with arrows & tunable white slider

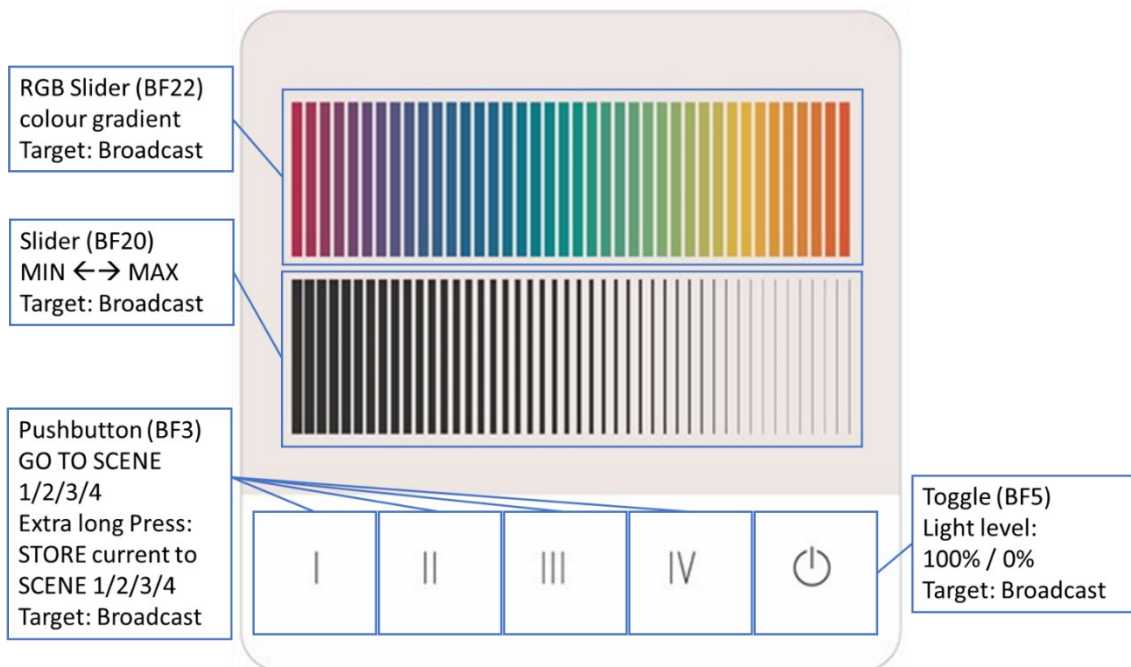

Layout Art. Nr.: G06A brightness Slider & RGB slider

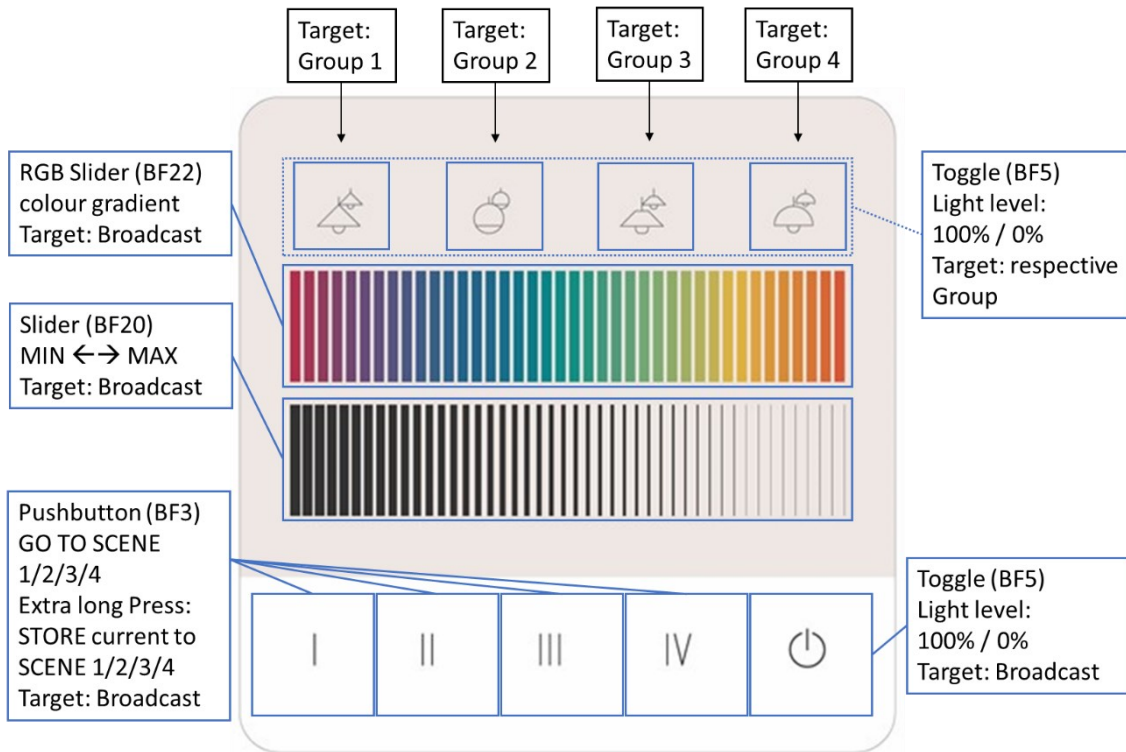

Layout Art. Nr.: G07A 4 groups on/off, brightness slider, RGB slider

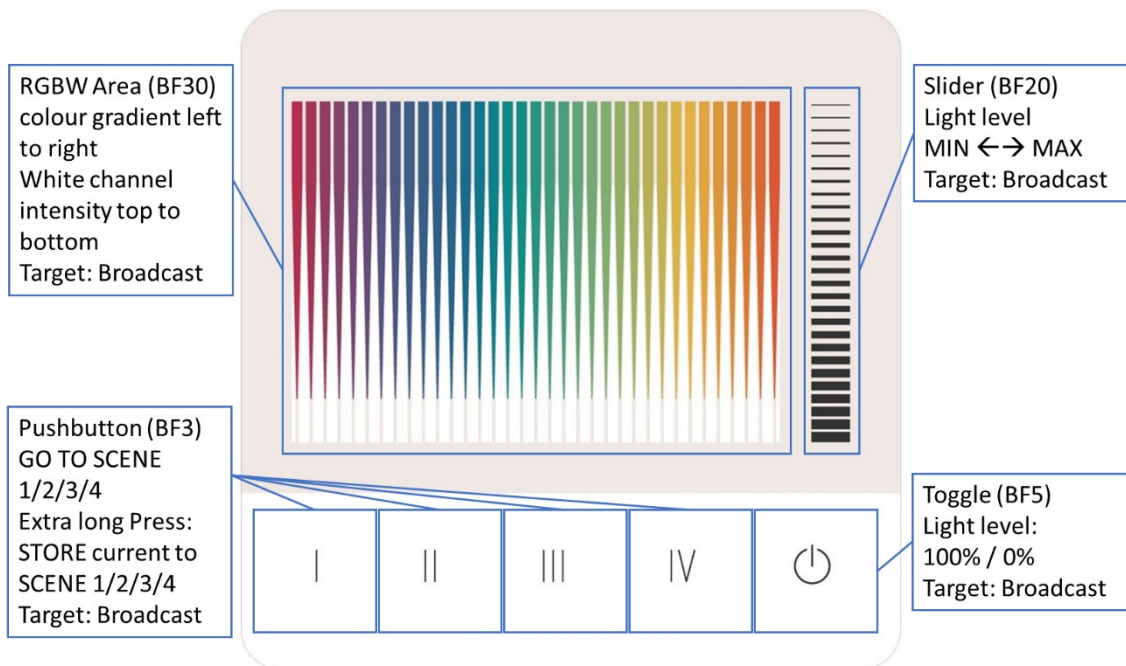

Layout Art. Nr.: G09A brightness slider & RGBW slider

Purchase information**Art. Nr. 24035410-G__**

GTIN 9010342013089

DALI-2 Touchpanel

please indicate the desired Layout: G01A to G08A below.

Art. Nr. 24035410-PS-G__

DALI-2 Touchpanel PS

Version with integrated DALI-PS 70mA

please indicate the desired Layout: G01A to G08A below.

Glass Standard layouts

Various layouts, overview:

https://www.lunatone.com/wp-content/uploads/2020/11/DALI-2-Touchpanel-Layouts_EN.pdf**Art. Nr. 24035410-G000**

unprinted glass

GTIN 9010342013652

Art. Nr. 24035410-G01A

dimming, 4 scenes

GTIN 9010342013669

Art. Nr. 24035410-G02A

dimming, 4 scenes, 4 groups

GTIN 9010342013676

Art. Nr. 24035410-G03A

dimming, 4 scenes, tunable white

GTIN 9010342013683

Art. Nr. 24035410-G04A

dimming, 4 scenes, tunable white, 4 groups

GTIN 9010342013690

Art. Nr. 24035410-G05A

dimming, 4 scenes, tunable white, 4 groups

GTIN 9010342013706

Art. Nr. 24035410-G06A

dimming, 4 scenes, colour RGB

GTIN 9010342013713

Art. Nr. 24035410-G07A

dimming, 4 scenes, colour RGB, 4 groups

GTIN 9010342013720

Art. Nr. 24035410-G08A

dimming, ceiling fan, blinds, 2 groups, tunable white, 4 scenes

GTIN 9010342013737

Art. Nr. 24035410-G09A

dimming, 4 scenes, colour and white RGB

GTIN 9010342013843

Glass sample sets:

Art. Nr. G000

3 pieces of unprinted glasses

Art. Nr.: G01A - Art. Nr.: G08A

Sample set of 3 pieces of according glasses

Art. Nr.: GMIX5

Set of 5 glasses - please state the desired article numbers (Art. Nr.: G01A - Art. Nr.: G08A)

Additional Information and Equipment

Touchpanel Layout configuration files for the DALI cockpit
https://www.lunatone.com/wp-content/uploads/2021/03/TouchpanelLayout_KonfigFiles.zip

DALI Cockpit - free configuration software for DALI systems
<https://www.lunatone.com/en/product/dali-cockpit/>

Lunatone DALI products
<https://www.lunatone.com/en>

Lunatone Datasheets and Manuals
<https://www.lunatone.com/en/downloads-az/>

DALI-2 Instancemode Information sheet
https://www.lunatone.com/wp-content/uploads/2021/10/DALI-2_Instance-Guide_EN_M0024.pdf

Contact

Technical Support:
support@lunatone.com

Requests: sales@lunatone.com

www.lunatone.com



Disclaimer

Subject to change. Information provided without guarantee. The datasheet refers to the current delivery.

The function in installations with other devices must be tested for compatibility in advance.