

artist of light

Specification

For LED Neon Flex Ribbon

C-SFR-F21D



CLEAR
LIGHTING

Table of Contents

Introduction	03
1. Specifications & Parameters	04
1.1 Dimensions of Light	
1.2 Technical Parameters	
1.3 Optical Parameters	
2. Functions & Features	05
2.1 Product Features	
2.2 Minimum Bend Diameter	
3. Types of Connector	05
3.1 Injection-Moulded Connector	
3.2 Sleeve Connector	
3.3 Snap Connector	
3.4 Anti-wicking Ferrule	
3.5 Male & Female Connector	
4. Mounting Profile	10
4.1 Plastic Profile	
4.2 Spring Clip Aluminum Profile	
4.3 Cable Exit Oriented Aluminum Profile	
(Applicable to Injection-moulded Connector Only)	
4.4 Corner Aluminum Profile	
(Applicable to Injection-moulded Connector Only)	
4.5 Bendable Stainless Steel Profile	
4.6 Recessed Mounting Profile	
5. Packaging	14
6. Appendix	14
6.1 Product Naming Convention	
6.2 Certificate	
6.3 Third-Party Test Report	
6.4 Reliability Test of Light	
6.5 Figures of Typical Characteristics	
6.6 (X,Y) Chromaticity Diagram	
6.7 Loading Chart	
6.8 Correlated Color Temperature	

Introduction

C-SFR-F21D is a member of the Artist of Light series coupled with intelligent LEDs for dynamic white, dome surface, ideal replacement for traditional neon gas lighting.

C-SFR-F21D is UL/cUL, CE, TUV and RoHS compliant for European Union and North American markets. Moreover, C-SFR-F21D has passed environmental resistance, optical, mechanical and electrical tests in our lab under the support of advanced experimental equipments and technology to ensure it meets the requirements of harsh environments.

Fully encapsulated in the flexible silicone tubing, assembled with patented connectors to achieve IP67 protection, applicable for various circumstances..

Color temperature tunable from 2200K to 5700K, which enable you to implement a lighting design consistently and efficiently that responds to your undefined and specific needs.

Applications:

1. Outdoor or Indoor Contour/Border Lighting
2. Architectural Outline/Decorative Lighting
3. Cove/Accent Lighting
4. Facade/Floor Lighting
5. Signage/Display Lighting
6. Hospital/Retail Lighting

1. Specifications & Parameters

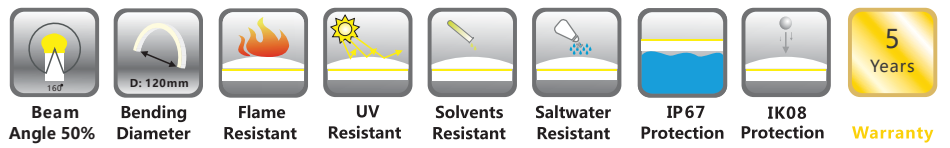

1.1 Dimensions of Light

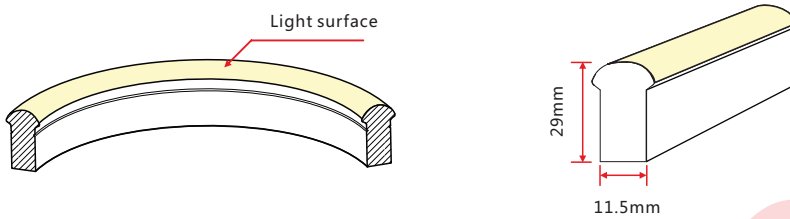

Note: Unless otherwise stated, the tolerance of the light is $\pm 0.3\text{mm}$.

1.2 Technical Parameters

Technical Parameters	
Article No.	C-SFR-F21D-24CV
Color	W/WW
Working Voltage	DC24V
Rated Power/m	12W
LED Qty/m	144LEDs
LED Distance	13.89mm
Min. Cutting Unit	12LEDs(1 unit)
Min. Cutting Length	83.3mm(1 unit)
Continuous Length	15m
Weight/m	490g
Storage Temperature	-40 ~ 60°C
Ambient Working Temperature	-40 ~ 55°C
Ambient Installation Temperature	-40 ~ 50°C
IP Rating	IP67



1.3 Optical Parameters

Photometric Data			
Article No.	C-SFR-F21D-24CV		
LED Type	SMD		
Beam Angle 50%	160°		
Color	CCT	Lumen/m	Power/m
2200 (WW)	2238 \pm 102K	>170Lm	
5700 (W)	5669 \pm 355K	>210Lm	
WW+W	3465 \pm 245K	>380Lm	12W

Candle Power Distribution

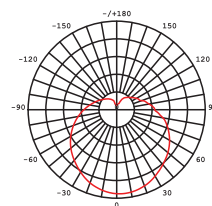

Illuminance Characteristics

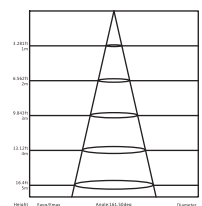

2. Functions & Features

2.1 Product Features

1. Dynamic white system with tunable color temperature from 2200K to 5700K
2. High quality SMD LED chip.
3. UV & flame resistant construction (silicone).
4. High color consistency & smooth illumination with invisible light dots.
5. Domed profile for large beam angle (160°).
6. High lumen output and IP rating (IP67).
7. The product IP rate is ultimately in line with properly applied IP rated connectors.
8. Ultra flexible with 120mm minimum bending diameter.
9. Easy installation and assembly with DIY accessories for joining and terminating.
10. Continuous length up to 15m by energized from one end.
11. Environmentally friendly & energy efficient.
12. Automated production, high reliability & long warranty.
13. 5 years life span.

2.2 Minimum Bend Diameter

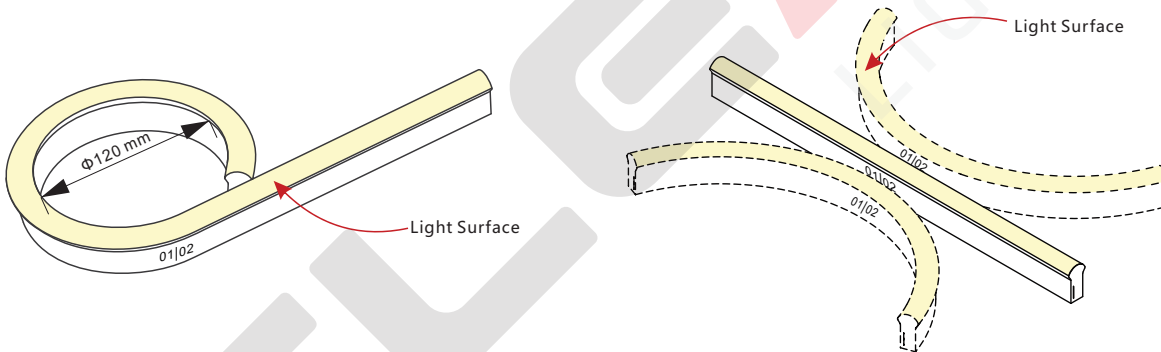

The light can only be bent laterally (opposite bend along to light surface).

Do not bend over allowed minimum bend diameter.

3. Types of Connector

3.1 Injection-moulded Connector

Note:
 1. Unless otherwise stated, the tolerance of the connector is $\pm 0.5\text{mm}$;
 2. Continuous length up to 15m by powering one end.



Injection-moulded Front Connector (bottom)

Connects light to power supply with pre-installed bottom feed cable, IP67. Cable length available in 0.3m, 1m, 3m, 5m, 10m.

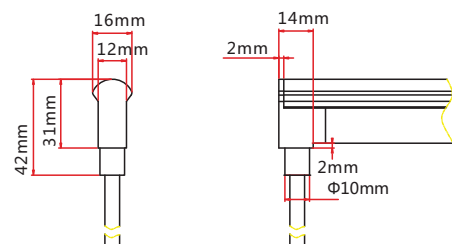

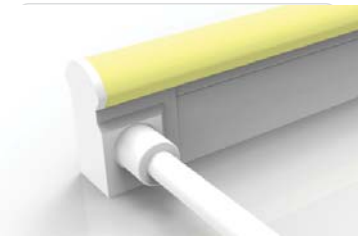

Injection-moulded Front Connector (side)

Connects light to power supply with pre-installed side feed cable, IP67. Cable length available in 0.3m, 1m, 3m, 5m, 10m, 15m, 20m.

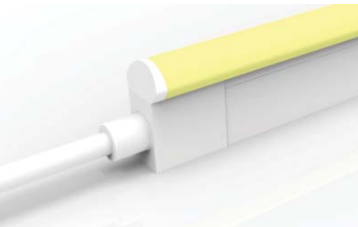
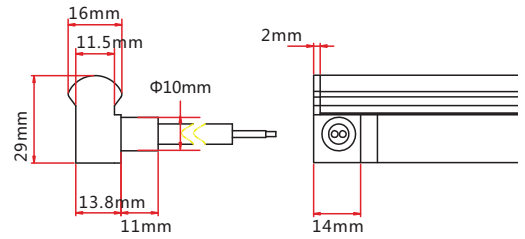

Injection-moulded Front Connector (top end)

Connects light to power supply with pre-installed end feed cable, IP67. Cable length available in 0.3m, 1m, 3m, 5m, 10m.

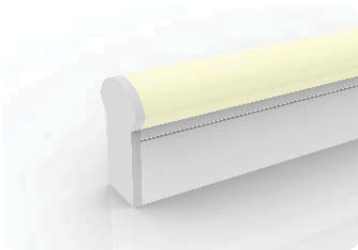
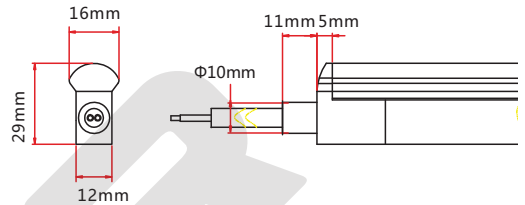

Injection-moulded End Cap

Pre-installed termination protection of the light, IP67.

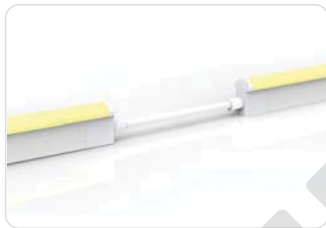
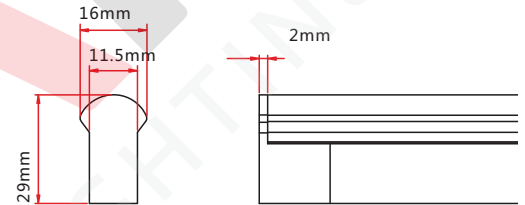

Injection-moulded Jumper

Connects two pieces of lights together with a flexible cable. IP67 Injection-moulded connector. L available in 0.3~1m.

Maximum 8 Jumpers in 20m
Maximum 4 Jumpers in 10m

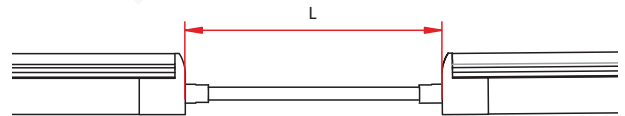

Injection-moulded T-feed

Connects two pieces of lights together with a T joint, energized from middle. IP67 Injection-moulded connector. L1 and L2 available in 0.15~0.5m. L3 available in 0.3-3m.

Maximum 8 T-feeds in 20m
Maximum 4 T-feeds in 10m

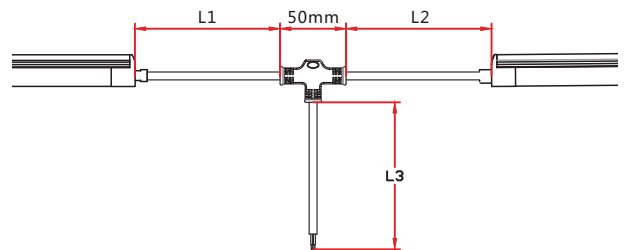

3.2 Sleeve Connector

Note:
 1. Unless otherwise stated, the tolerance of the connector is $\pm 0.5\text{mm}$;
 2. Continuous length up to 15m by powering one end.

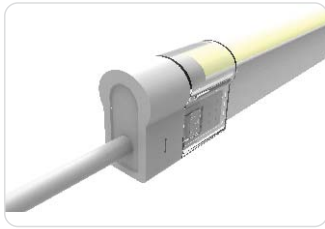

Sleeve Front Connector

Connects light to power supply. IP40 DIY connector. Cable length available in 0.3m, 1m, 3m, 5m, 10m, 15m, 20m.

Feed connector*1 (Three-pin)
 PC cover*1
 Anti-skidding clips*2

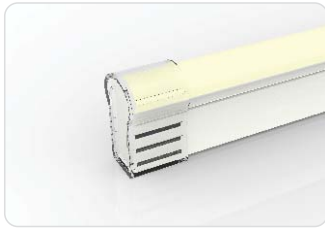
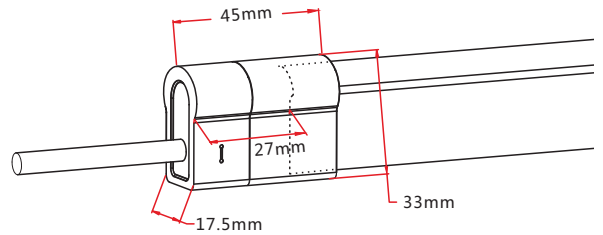

Sleeve End Cap

Termination protection of the light. IP40 DIY connector.

Shading Sheat*1
 PC cover*1

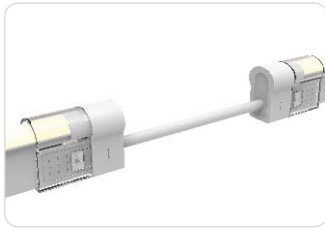
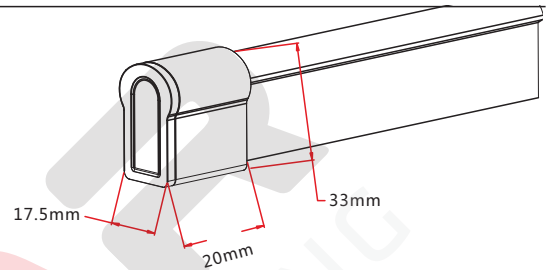

Sleeve Jumper

Connects two pieces of lights together with a flexible cable. IP40 DIY connector. L available in 0.3m, 1m and 3m.

Double-end feed connector*1 (Three-pin)
 PC cover*2
 Anti-skidding clips*4

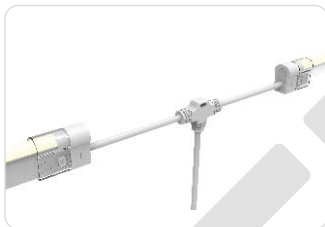
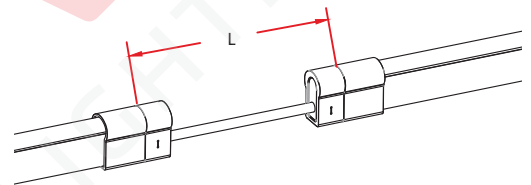

Sleeve Power T-feed

Connects two pieces of lights together with a T joint, energized from middle. IP40 DIY connector. L1 and L2 available in 0.3m.

T joint*1 (Three-pin)
 PC cover*2
 Anti-skidding clips*4

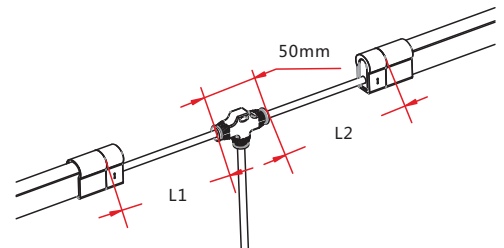

3.3 Snap Connector

Note:

1. Unless otherwise stated, the tolerance of the connector is $\pm 0.5\text{mm}$;
2. Continuous length up to 15m by powering one end.



Snap Front Connector

Connects light to power supply. IP67 DIY connector. Cable length available in 0.3m, 1m, 3m, 5m, 10m, 15m, 20m.

- Feed connector*1 (Three-pin)
- Silicone gasket*1
- U steel plate*1
- Anti-skidding clip*1
- PC Cover*1

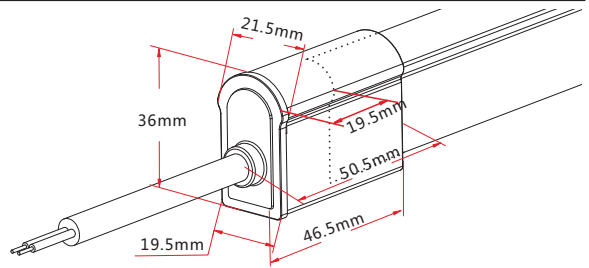

Snap Front Connector (side right/left)

Connects light to power supply. IP67 DIY connector. Cable length available in 0.3m, 1m, 3m, 5m, 10m, 15m, 20m.

- Feed connector*1 (Three-pin)
- Silicone gasket*1
- U steel plate*1
- Anti-skidding clip*1
- PC Cover*1

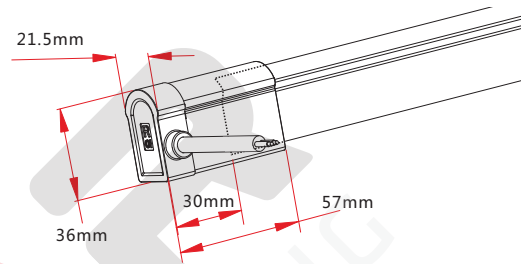

Snap Front Connector(bottom)

Connects light to power supply. IP67 DIY connector. Cable length available in 0.3m, 1m, 3m, 5m, 10m, 15m, 20m.

- Feed connector*1 (Three-pin)
- Silicone gasket*1
- U steel plate*1
- Anti-skidding clip*1
- PC Cover*1

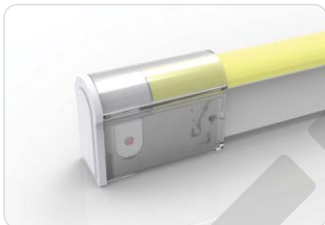
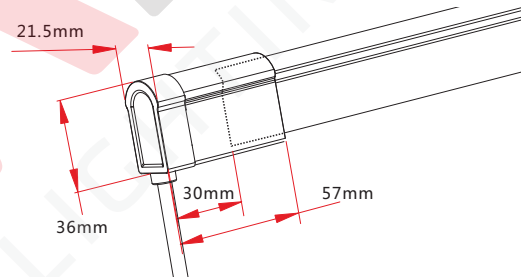

Snap End Cap

Termination protection of the light. IP67. DIY connector.

- Tail plug*1
- Silicone gasket*1
- U steel plate*1
- Anti-skidding clip*1
- PC Cover*1

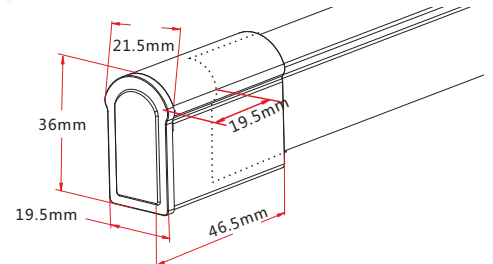

Snap Jumper

Connects two pieces of lights together with a flexible cable. IP67 DIY connector. L available in 0.3m, 1m and 3m.

- Double-end feed connector*1 (Three-pin)
- Silicone gasket*2
- U steel plate*2
- Anti-skidding clip*2
- PC Cover*2

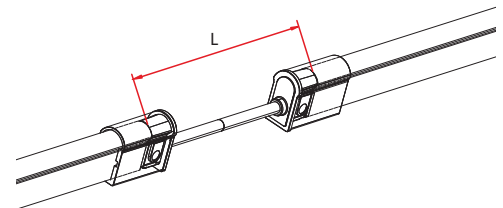

Snap Power T-feed

Connects two pieces of lights together with a T joint, energized from middle. IP67 DIY connector. L1 and L2 available in 0.3m.

- T joint*1 (Three-pin)
- Silicone gasket*2
- U steel plate*2
- Anti-skidding clip*2
- PC Cover*2

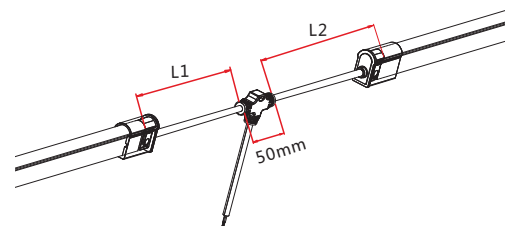

3.4 Anti-wicking Ferrule

Note: Unless otherwise stated, the tolerance is $\pm 0.5\text{mm}$.

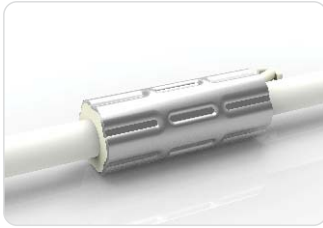

Anti-wicking Ferrule

The anti-wicking ferrule is located at 115mm ($\pm 5\text{mm}$ tolerance) from the connector on the cable.

For protection against water ingress from inside of cable wire and hence damage the light.

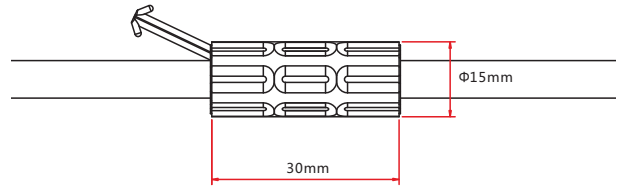

3.5 Male & Female Connector

Note: Unless otherwise stated, the tolerance is $\pm 2\text{mm}$.



Male & female Connector

For plug and play cable junction, DIY or Pre-installed connector, IP68

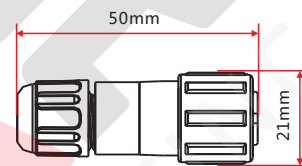

4. Mounting Profile

4.1 Plastic Profile

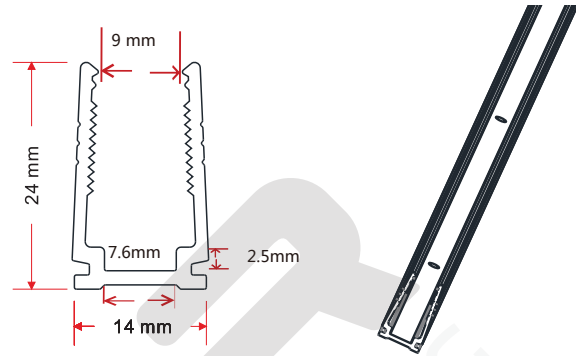
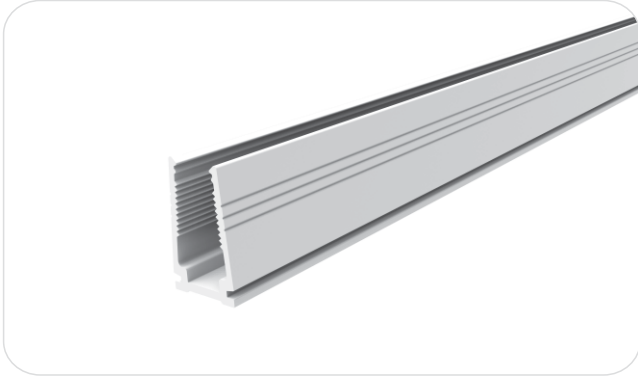

Note: Unless otherwise stated, the tolerance of the profile is $\pm 0.5\text{mm}$.

Installation Way

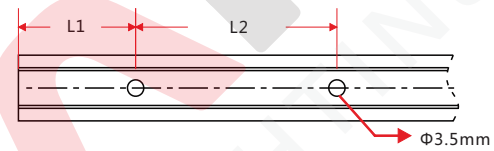

Model	W*H(mm)	Standard Length (mm)	L1 (mm)	L2 (mm)	Screw Hole (mm)	Hole Number	For Product
F21-PC/PL	14*24	500	50	200	$\Phi 3.5$	3	F11, F15, F21
		1000	100	200	$\Phi 3.5$	5	F11, F15, F21
		2000	100	200	$\Phi 3.5$	10	F11, F15, F21

4.2 Spring Clip Aluminum Profile

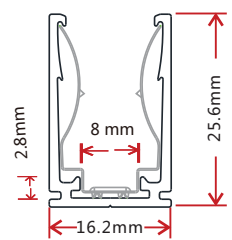
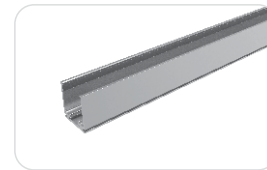
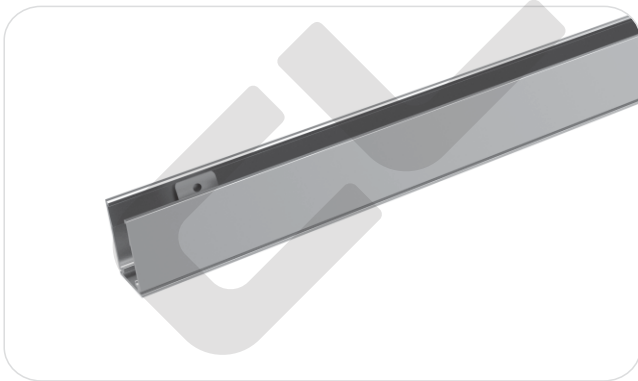

Note: Unless otherwise stated, the tolerance of the profile is $\pm 0.5\text{mm}$.

Installation Way

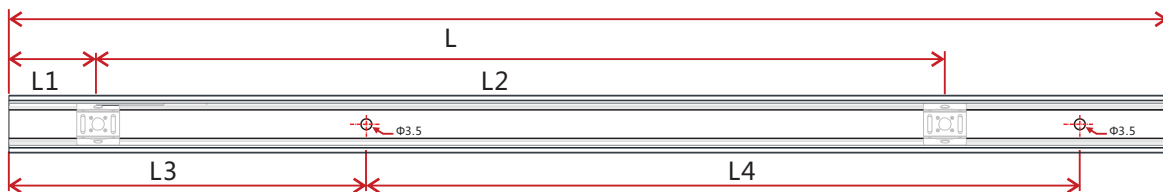

Model	W*H(mm)	Standard Length(mm)	L1(mm)	L2(mm)	L3(mm)	L4(mm)	Hole Screw(mm)	Hole Number	Clip Number
F21-SCA/PL	16.2*25.6	35	17.5	/	5	25	$\Phi 3.5$	2	1
		500	25	225	50	200	$\Phi 3.5$	3	3
		1000	25	237.5	100	200	$\Phi 3.5$	5	5
		2000	25	243.8	100	200	$\Phi 3.5$	10	9

4.3 Cable Exit Oriented Aluminum Profile (Applicable to Injection-moulded Connector Only)

4.3.1 Spring Clip Aluminum Profile, Middle Feed

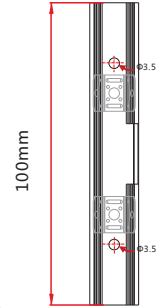
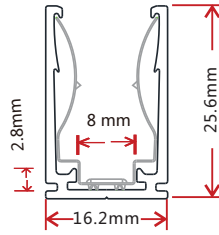

Model: F21-SCA/PL-M

Note: Unless otherwise stated, the tolerance of the profile is $\pm 0.5\text{mm}$.

4.3.2 Spring Clip Aluminum Profile, Side Feed From Left

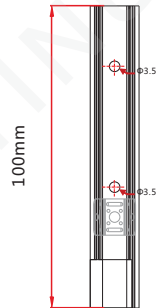
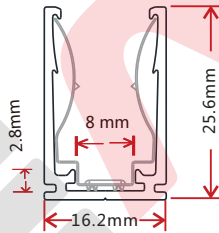

Model: F21-SCA/PL-SL

Note: Unless otherwise stated, the tolerance of the profile is $\pm 0.5\text{mm}$.

4.3.3 Spring Clip Aluminum Profile, Bottom Feed

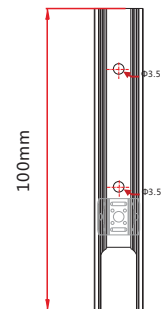
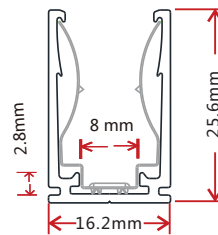
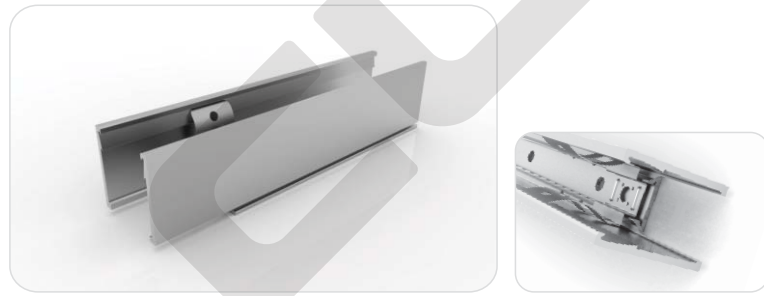

Model: F21-SCA/PL-B

Note: Unless otherwise stated, the tolerance of the profile is $\pm 0.5\text{mm}$.

4.3.4 Spring Clip Aluminum Profile, Side Feed From Right

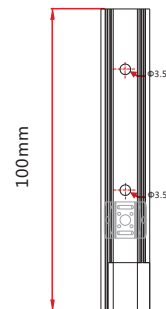
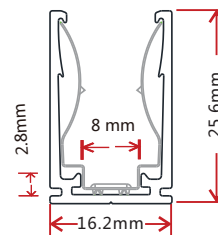

Model: F21-SCA/PL-SR

Note: Unless otherwise stated, the tolerance of the profile is $\pm 0.5\text{mm}$.

4.4 Corner Aluminum Profile (Applicable to Injection-moulded Connector Only)

4.4.1 L Shape Spring Clip Aluminum Profile

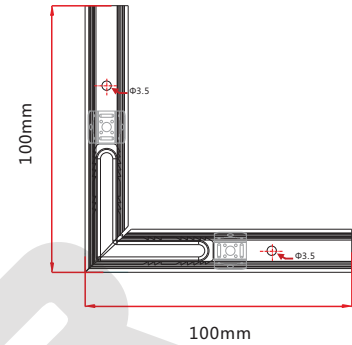
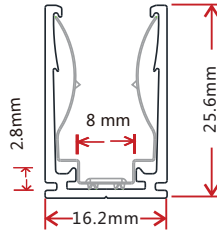

Model: F21-SCA/PL-L

Note: Unless otherwise stated, the tolerance of the profile is $\pm 0.5\text{mm}$.

4.4.2 Inward L Shape Spring Clip Aluminum Profile

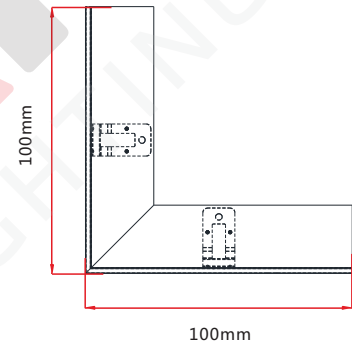
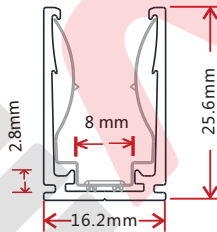

Model: F21-SCA/PL-IL

Note: Unless otherwise stated, the tolerance of the profile is $\pm 0.5\text{mm}$.

4.4.3 Outward L Shape Spring Clip Aluminum Profile

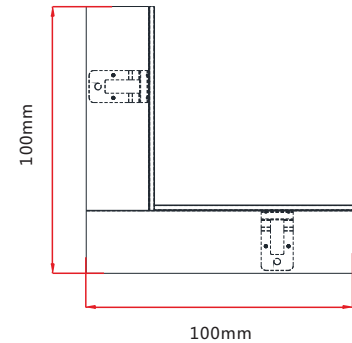
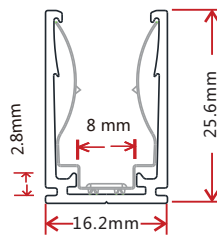

Model: F21-SCA/PL-OL

Note: Unless otherwise stated, the tolerance of the profile is $\pm 0.5\text{mm}$.

4.4.4 T Shape Spring Clip Aluminum Profile

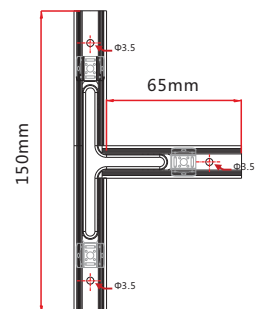
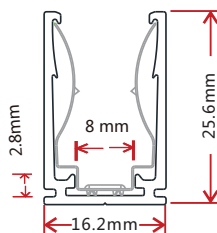

Model: F21-SCA/PL-T

Note: Unless otherwise stated, the tolerance of the profile is $\pm 0.5\text{mm}$.

4.4.5 X Shape Spring Clip Aluminum Profile

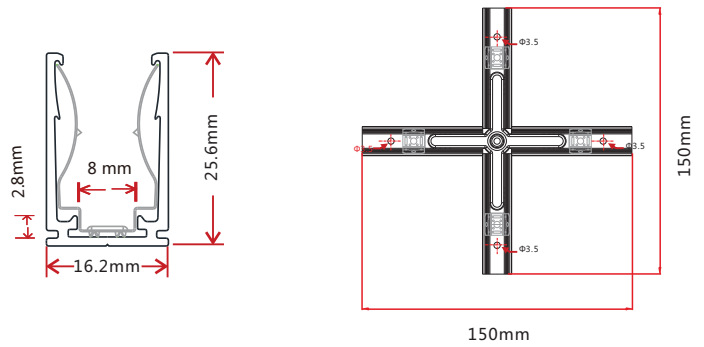
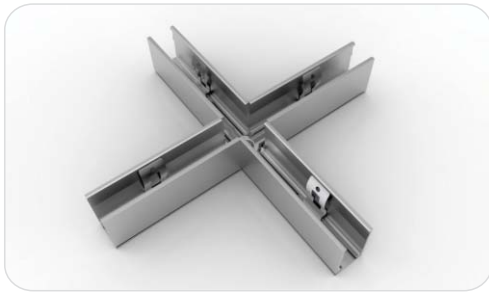

Model: F21-SCA/PL-X

Note: Unless otherwise stated, the tolerance of the profile is $\pm 0.5\text{mm}$.

4.5 Bendable Stainless Steel Profile

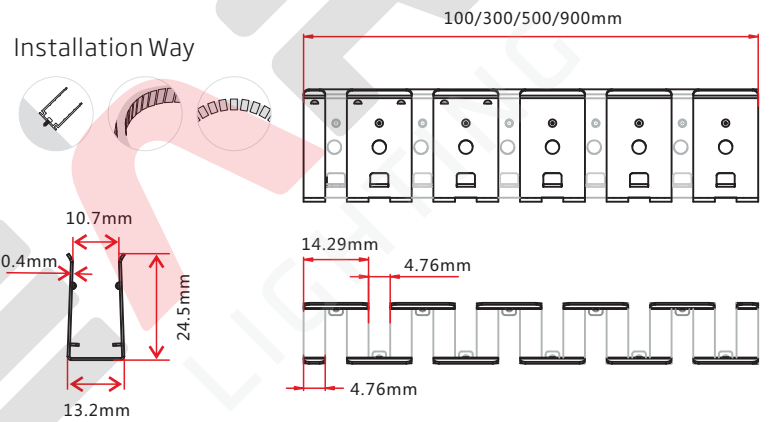

Model: F21-CS/PL

Note: Unless otherwise stated, the tolerance of the profile is $\pm 0.5\text{mm}$.

4.6 Recessed Mounting Profile

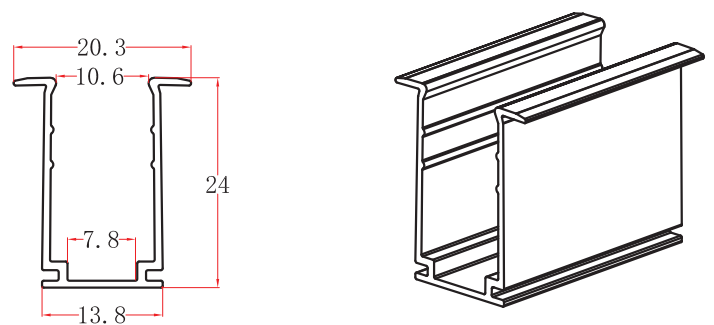

Note: Unless otherwise stated, the tolerance of the profile is $\pm 0.5\text{mm}$.

Installation Way

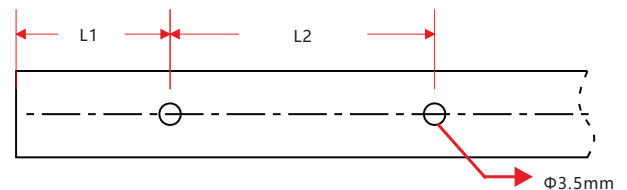

Model	W*H(mm)	Standard Length (mm)	L1 (mm)	L2 (mm)	Screw Hole (mm)	Hole Number	For Product
F21-RMA/PL	18*13.2	35	5	25	Ø3.5	2	F21
		500	50	200	Ø3.5	3	F21
		1000	100	200	Ø3.5	5	F21
		2000	100	200	Ø3.5	10	F21

5. Packaging

Packaging Method



Plastic Plate

White Box

Carton

Packaging Detail

Light Length	White Box Dimension (cm)	Carton Dimension (cm)	Numbers of White Box	Carton Weight (kg)
5m	39*5.2*50	52*41*28	5	14
10m	51*5.2*62	64*53*28	5	26
10m	51*5.2*62	64*53*17.5	3	16
20m	68*5.2*79	81*70*12.5	2	22

6. Appendix

6.1 Product Naming Convention

C-SFR-XXX(-)X-XX-XXX-XXX-XXX-XXX

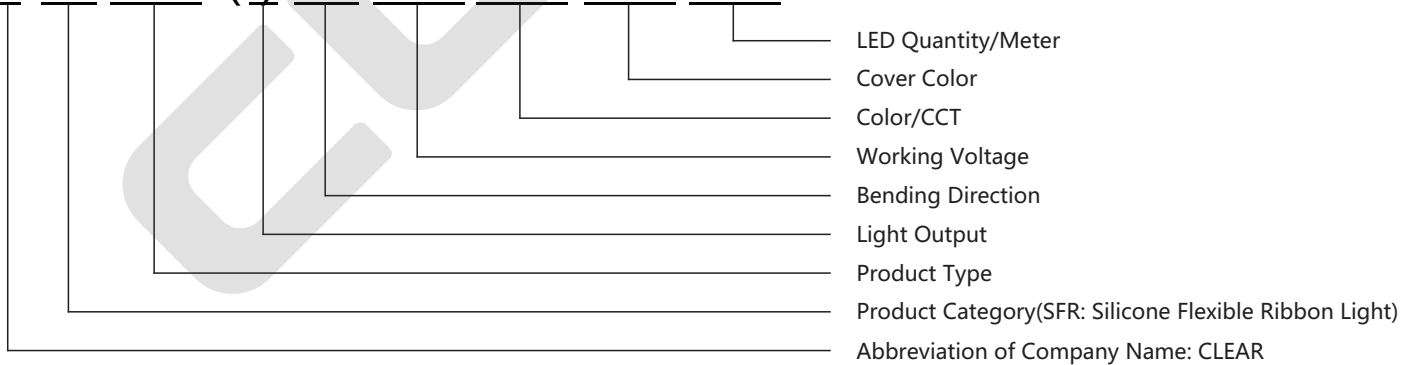

For Example: C-SFR-F21D-HB-24CC-22K~57K-WM-144

6.2 Certificate

Certificating Type	Testing Organization	Certificate Serial Number	Report Reference
UL 2108	UL	20160726-E360029	E360029-20130322
CE-EMC	SGS	SZEM1712012372LMV	SZEM171201237201

6.3 Third-Party Test Report

Testing Item	Testing Organization	Report Number
RoHS	SGS	CANEC1202163502 A01
IP68: Screw type	TUV SUD	68.140.12.136.02
IP68: Clasp type	SGS	GZES140200135301 GZES140200135401 GZES140200135501 GZES140200135701 GZES140200135801
IPX8: Molding type	SGS	SZES141200357301 SZES141200357401 SZES141200357501
IPX8: Snap type	SGS	GZES160600792031

>>Note: The testing reports and certificates are available from the related official website.

6.4 Reliability Test of Light

TESTING ITEM	PERFORMANCE	STANDARD/REFERENCE VALUE/DESCRIPTION
PHOTOMETRIC TESTING	Spectrum Analysis	IES LM 79 (lumen, CCT, CRI, XY, SDCM, wave length)
	Photometric Distribution	IES LM 79(lumen intensity distribution & Lux diagram)
	Lumen Maintenance & Life Time	IES LM84 & IES TM28
TEMPERATURE RISE TESTING	Normal Temperature Test	UL1598 & UL2388 & IEC60598-1 & IEC60598-2-21
	Abnormal Operation Test	UL1598 & UL2388 & IEC60598-1 & IEC60598-2-21
MECHANICS & PHYSICS TESTING	Bending Test	Manufacturer-defined, 500 cycles
	Swing Test	UL2388, >750 cycles
	Tensile Test	Manufacturer-defined, > the weight of light in maximum connection length with both ends feed
	Twist Test	Manufacturer-defined, >200 cycles
	Ball Impact	UL1598 & UL2388 & IEC60598-1 & IEC60598-2-21
	IK07 IK08	IEC62262
WEATHERING TESTING	Swimming Pool Water Immersion Test	GB9667, PH6.8-7.6, free chlorine 0.3-0.6mg/L
	Sea Water Immersion Test	IEC60598-1, Salinity 4%
	Salt Spray Test	IEC68-2-11
	Outdoor Exposure	Manufacturer-defined
ENVIROMENT TESTING	Flame Resistant Test	UL94
	UV Exposure Test	ASTMG 154 , ISO 4892-3 , UVA@340nm
	IPX5 IPX6 IPX7 IPX8	IEC60529
ENDURANCE & THERMAL TEST LAB	Temperature Shock Test	Manufacturer-defined , -40°C-60°C (typical temperature range)
	Constant Temperature Test	Manufacturer-defined , 70°C (typical temperature)

6.5 Figures of Typical Characteristics

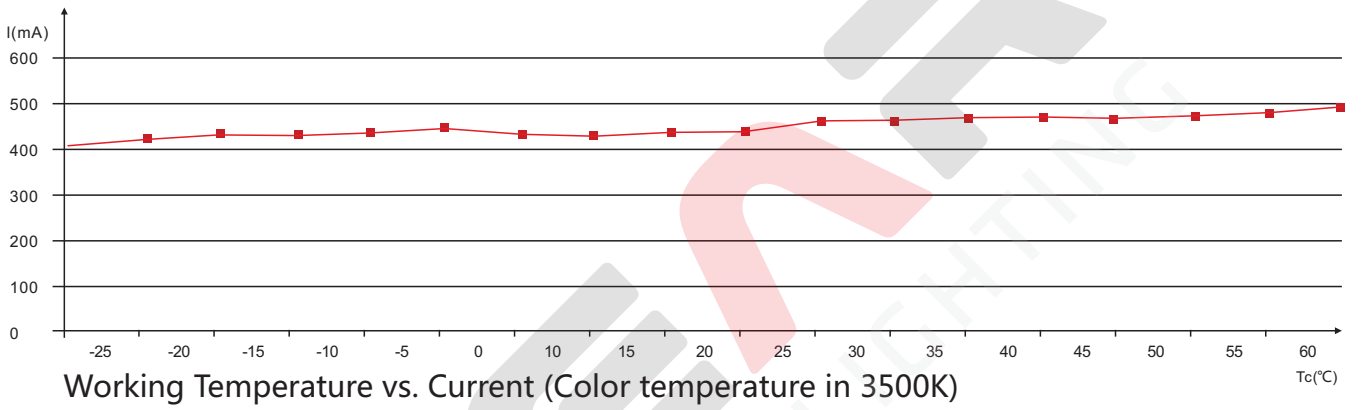
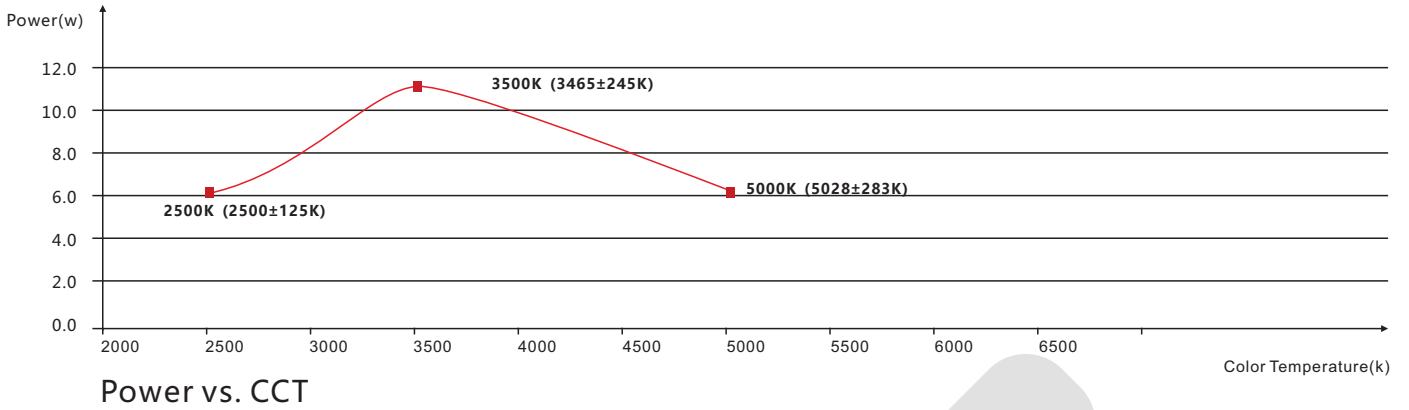

6.6 (X,Y) Chromaticity Diagram

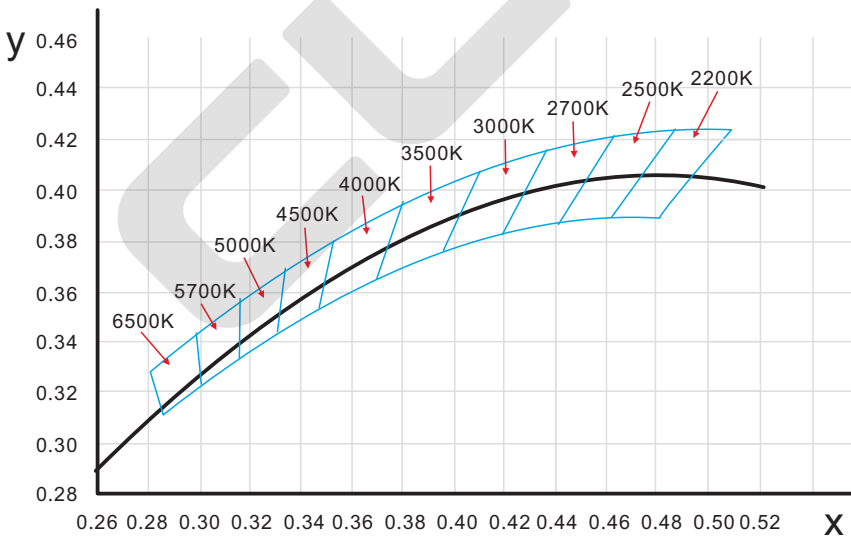

6.7 Loading Chart

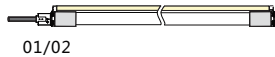
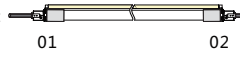
Type.	Rated Power /mtr	Power Supply											
		35w	60w	75w	80w	100w	120w	150w	120w	150w	185w	240w	320w
F21	6.5w/7.2w/8w	3m	6m	7.5m	8m	10m	12m	15m			18m	24m	30m
	10.6w/11w/12w	2m	3.5m	4.5m	5m	6m	7m	10m			12m	14m	20m
	15w	2m	3m	4m	4.2m	5m			6m	8m	10m		
Energizing Way		DC input 						DC input  DC input					

Note: 1. These are the light maximum recommended running length subject to selected power supply.
 2. For example: It is recommended to use one 80W power supply loading maximum 8m light (7.2w/m) or maximum 5m light (12w/m) by energizing the light one end.

6.8 Correlated Color Temperature

ANSI STANDARD

Nominal CCT Categories

Nominal CCT	Target CCT and tolerance(K)	Target D_{uv}	D_{uv} Tolerance Range
2200K	2238 ±102	0.0000	T_x :CCT of the source
2500K	2460±120	0.0000	For $T_x < 2870K$
2700K	2725 ±145	0.0000	0.000±0.0060
3000K	3045±175	0.0001	For $T_x \geq 2870K$
3500K	3465±245	0.0005	$D_{uv}(T_x) \pm 0.0060$
4000K	3985±275	0.0010	where
4500K	4503±243	0.0015	$D_{uv}(T_x) = 57700 \times (1/T_x)^2$
5000K	5029±283	0.0020	-44.6 x (1/Tx)
5700K	5667±355	0.0025	+0.00854
6500K	6532±510	0.0031	
Flexible CCT (2200-6500K)	$T_F^{1)} \pm \Delta T^{2)}$	$D_{uv} T_F^{3)}$	

Remark:

- 1) T_F is chosen to be at 100K steps (2300,2400,.....,6400K),excluding the ten nominal CCTs listed in Table 1.
- 2) $\Delta T = 1.1900 \times 10^8 \times T^3 - 1.5434 \times 10^4 \times T^2 + 0.7168 \times T - 902.55$
- 3) Same as in the D_{uv} Tolerance Range.