

 **Lunatone**

# **INPUT DEVICES, CONTROL UNITS & SENSORS**





# INPUT DEVICES, CONTROL UNITS & SENSORS

Lunatone control devices and operating modules are flexible, user-friendly and can be easily adapted to a wide range of applications. Various functions can be programmed and commands can be

sent to individual addresses, groups or to the entire installation. The product range includes pushbutton couplers, rotary dimmers, Touchpanels and many other control units and sensor modules.

## TABLE OF CONTENTS

## Folder A

|  |    |  |    |
|--|----|--|----|
| DALI-2 Display 4" and 7"                     | 2  | DALI 100K - DALI interface for 100kΩ potentiometer                               | 23 |
| DALI-2 Display 7" Emergency                  | 4  | EnOcean DALI-2 MC  | 24 |
| DALI-2 Display Bus Extension                 | 5  | DALI GC(-A) - controlling two DALI groups  | 24 |
| DALI-2 Touchpanel                            | 6  | DALI SC(-A) - controlling four DALI scenes                                       | 25 |
| DALI Touchpanel                              | 8  | DALI LR PS 20mA - automatic power reduction / night-time<br>brightness reduction | 25 |
| DALI Bluetooth Interface                     | 8  | DALI-2 Sequencer - recalling command sequences                                   | 26 |
| DALI Touchpanel Bluetooth 4.0                | 9  | DALI CDC - time based colour temperature control                                 | 27 |
| DALI-2 KNX Room Controller                   | 10 | DALI-2 RTC+ Timer  | 28 |
| DALI-2 Room Controller                       | 10 | DALI NFC App - configuration of basic settings                                   | 28 |
| DALI Cockpit Mobile - Smartphone application | 11 | DALI Daylight Interface  | 29 |
| DALI ROT                                     | 12 | DALI-2 Audio Interface   | 29 |
| DALI-2 ROT                                   | 14 | DALI-2 CS  | 30 |
| DALI-2 ROT Touch                             | 16 | DALI-2 CS Integration THP LE   | 34 |
| DALI-2 Switch Cross NFC                      | 17 | DALI-2 CS Mini   | 35 |
| wDALI Switch Cross                           | 18 | DALI-2 CS Corridor   | 36 |
| wDALI Remote                                 | 19 | DALI CS with 20mA DALI bus power supply  | 37 |
| wDALI MC - wireless pushbutton coupler       | 20 | DALI SI, SI-1L   | 37 |
| DALI-2 MC - pushbutton coupler               | 20 | DALI-2 LS - light sensor   | 38 |
| DALI-2 MC1L - pushbutton coupler             | 21 | DALI Temp - temperature sensor   | 38 |
| DALI-2 MC4L - pushbutton coupler             | 22 | Overview folder A-E  | 39 |
| DALI-2 MC1L PS, MC2L PS                      | 22 |  |    |
| DALI-2 MC4L POTI - pushbutton coupler        | 23 |  |    |

# DALI-2 Display 4" and 7"

The DALI-2 Display with capacitive touch and 24 bit colour depth allows depending on the model, commissioning as well as control and operation of a DALI system. The DALI-2 Display can be individually designed using numerous widgets. Supported functions include dimming and switching, recall of scenes, RGB

colour management and colour temperature control. The display has a DALI and a WLAN interface. Depending on the model, it is also possible to measure and display the room temperature, humidity, air pressure and air quality via integrated sensors.



| NAME                           | ARTICLE NUMBER | BRIEF DESCRIPTION   | INTERFACE            | COLOUR | OPERATING TEMP. (TA) | DIMENSIONS (MM) |
|--------------------------------|----------------|---|----------------------|--------|----------------------|-----------------|
| DALI-2 Display 7" (white)      | 86456840-W     | configurable control elements for switching, dimming, scenes and colour control   | DALI, WLAN, Ethernet | white  | -10 ... +50°C        | 178×111×8       |
| DALI-2 Display 7" plus (white) | 86456840-P-W   | configurable control elements for switching, dimming, scenes and colour control, <b>addressing, time switch, sequencer, circadian daylight schedule</b> | DALI, WLAN, Ethernet | white  | -10 ... +50°C        | 178×111×8       |
| DALI-2 Display 7" (black)      | 86456840-B     | configurable control elements for switching, dimming, scenes and colour control   | DALI, WLAN, Ethernet | black  | -10 ... +50°C        | 178×111×8       |
| DALI-2 Display 7" plus (black) | 86456840-P-B   | configurable control elements for switching, dimming, scenes and colour control, <b>addressing, time switch, sequencer, circadian daylight schedule</b> | DALI, WLAN, Ethernet | black  | -10 ... +50°C        | 178×111×8       |
| DALI Display 4" (white)        | 86456841-W     | configurable control elements for switching, dimming, scenes and colour control   | DALI, WLAN           | white  | -10 ... +50°C        | 88×88×8,5       |
| DALI-2 Display 4" plus (white) | 86456841-P-W   | configurable control elements for switching, dimming, scenes and colour control, <b>addressing</b>  | DALI, WLAN           | white  | -10 ... +50°C        | 88×88×8,5       |
| DALI Display 4" (black)        | 86456841-B     | configurable control elements for switching, dimming, scenes and colour control   | DALI, WLAN           | black  | -10 ... +50°C        | 88×88×8,5       |
| DALI-2 Display 4" plus (black) | 86456841-P-B   | configurable control elements for switching, dimming, scenes and colour control, <b>addressing</b>  | DALI, WLAN           | black  | -10 ... +50°C        | 88×88×8,5       |

## Installation example DALI-2 Display 4"

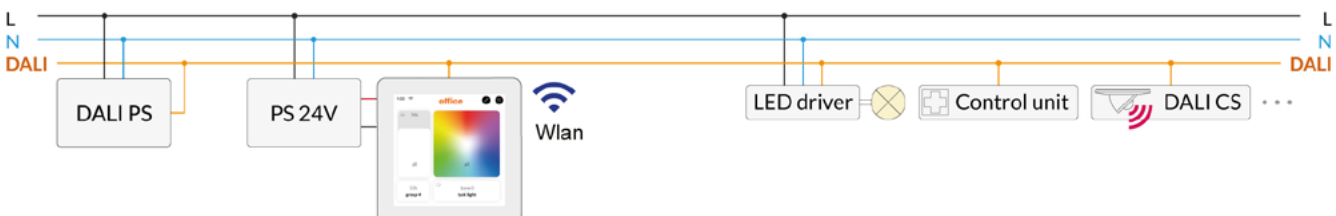

### The user interface of the DALI-2 Display

The user interface of the DALI-2 Display is made up of individual pages (boards) and the operating elements (widgets) on them.

**Board**  
name of the page (board) is displayed on top, any number of boards can be created.

**Widgets**  
control elements with different functions: ON/OFF, dimming, colour temperature, colour, scenes, visualization of sensor values, links to boards, DALI-2 instances, etc.



**Configuration menu**  
Settings for boards, general settings, and settings for the DALI system

**Editor**  
for creating and editing boards and widgets

**Navigation**  
move finger up and down on the screen to navigate up and down, swipe right and left to switch between boards

### Automation: Circadian Daylight Schedule (Human Centric Lighting) – preview DALI-2 Display 7" plus

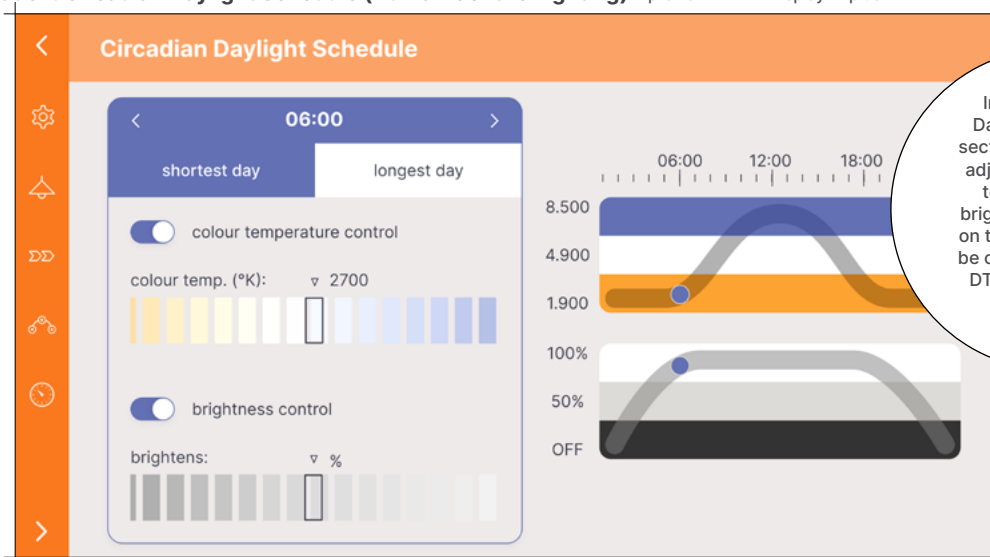

In the "Circadian Daylight Schedule" section, the automatic adjustment of colour temperature and brightness depending on the time of day can be configured for DALI DT8 luminaires with tunable white capability.

### Automation: Sequences – preview DALI-2 Display 7" plus



In the "Sequence" section, time-based DALI command sequences can be defined.

Sequences can be started and stopped via widgets.



# DALI-2 Display 7" Emergency

The DALI-2 Display 7" Emergency is a multifunctional control and operating unit for DALI emergency light systems. On the home screen the display shows the status of the emergency lighting system and results of the last performed tests. The configuration menu can be used to schedule and automate

communication, function and duration tests. The device thus allows automatic and uncomplicated monitoring and functionality checks of the emergency lighting system. The test results are logged and can be emailed or downloaded via the display's web interface.

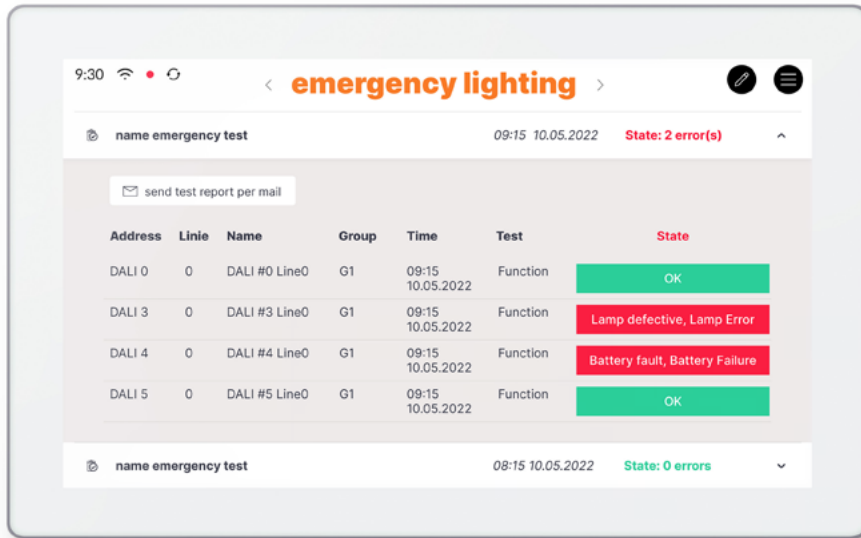

| NAME                                   | ARTICEL NUMBER  | BRIEF DESCRIPTION   | INTERFACE            | COLOUR | OPERATING TEMP. (TA) | DIMENSIONS (MM) |
|--|-----------------|---|----------------------|--------|----------------------|-----------------|
| DALI-2 Display 7" Emergency white      | 86456840-EM-W   | capacitive touchscreen with 24-bit colour depth, emergency light unit for 64 DALI addresses   | DALI, WLAN, Ethernet | white  | -10 ... +50°C        | 178x111x8       |
| DALI-2 Display 7" Emergency Plus white | 86456840-P-EM-W | capacitive touchscreen with 24-bit colour depth, emergency light unit for 64 DALI addresses, including all functionality of the DALI-2 Display Plus | DALI, WLAN, Ethernet | white  | -10 ... +50°C        | 178x111x8       |
| DALI-2 Display 7" Emergency black      | 86456840-EM-B   | capacitive touchscreen with 24-bit colour depth, emergency light unit for 64 DALI addresses   | DALI, WLAN, Ethernet | black  | -10 ... +50°C        | 178x111x8       |
| DALI-2 Display 7" Emergency Plus black | 86456840-P-EM-B | capacitive touchscreen with 24-bit colour depth, emergency light unit for 64 DALI addresses, including all functionality of the DALI-2 Display Plus | DALI, WLAN, Ethernet | black  | -10 ... +50°C        | 178x111x8       |

### Installation example DALI-2 Display 7" Emergency

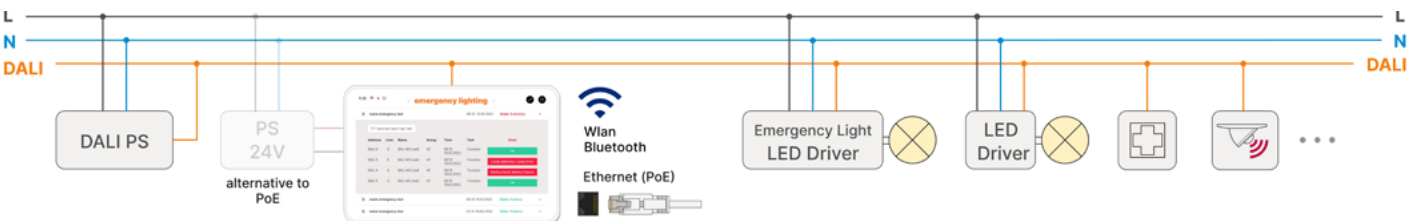

Emergency Tests: communication, function and duration test - preview: DALI-2 Display 7" Emergency

Emergency test reports: Full test report logs can be downloaded from the display's web interface

Three different emergency test types are available for different emergency devices or emergency groups and can be scheduled for different time intervals

## DALI-2 Display Bus Extension

The module is used in combination with a DALI-2 Display 7" Plus or DALI-2 Display 7" Emergency. It allows a DALI system expansion with up to 3 additional DALI lines.

The device has 2 Ethernet sockets for connecting the DALI-2 Display and the local network. Up to three DALI lines can be connected via terminals DA1, DA2 and DA3.

The Display Bus Extension Module requires a 24V supply (suitable power supply unit: PS 24V, 300mA, Art. Nr.: 24166012-24HS). The DIN rail housing is suitable for installation in control cabinets.



| NAME                         | ARTICLE NUMBER | BRIEF DESCRIPTION  | INTERFACE   | COMPATIBILITY                               | SUPPLY | DIMENSIONS (MM) |
|------------------------------|----------------|--|---|---|--------|-----------------|
| DALI-2 Display Bus Extension | 86451848       | device to increase the number of DALI lines for DALI-2 Display 7" Plus & Emergency | network socket - Ethernet<br>network socket - Display | 86456840-P<br>86456840-EM<br>86456840- P-EM | 24VDC  | 98x18x56        |

### Installation example DALI-2 Display Bus Extension

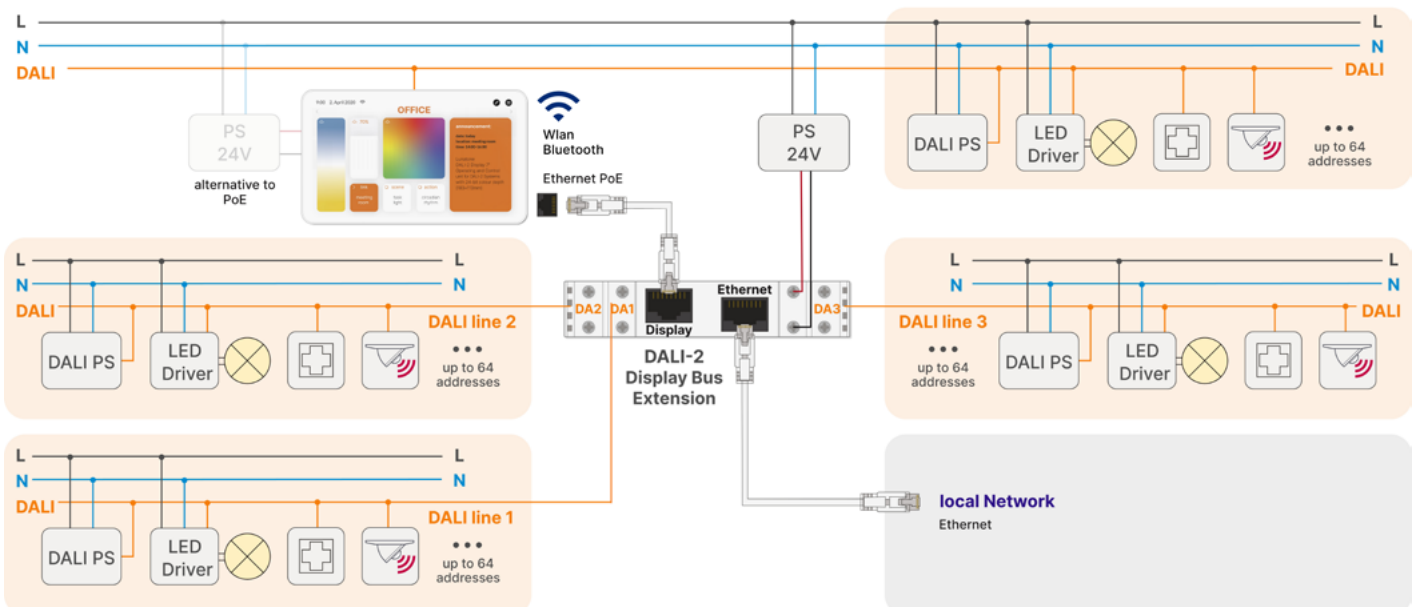

# DALI-2 Touchpanel

The DALI-2 Touchpanel is a multifunctional control unit with up to 16 freely configurable buttons. The number of buttons and the associated DALI commands can be set in the PC software DALI Cockpit. The device can be adapted to a wide variety of applications. Several standard user interfaces are available and customer specific designs can be implemented upon request.

In addition to the standard functions of dimming, switching, scene recall, etc., predefined macros such as setting the colour temperature, dynamic scenes and sequences, as well as user defined command lists are supported.



| NAME                                  | ARTICLE NUMBER  | BRIEF DESCRIPTION  | SUPPLY                                    | DIMENSIONS (MM) |
|---------------------------------------|-----------------|--|---|-----------------|
| DALI-2 Touchpanel                     | 24035410-G__    | DALI-2 Touchpanel with a user interface of choice: G01A to G09A                            | via DALI line                             | 87×87×9,5       |
| DALI-2 Touchpanel with DALI PS (70mA) | 24035410-PS-G__ | DALI-2 Touchpanel with 70mA DALI bus power supply + user interface of choice: G01A to G09A | mains (integrated DALI power supply 70mA) | 88×88×38,5      |

### Installation example DALI-2 Touchpanel

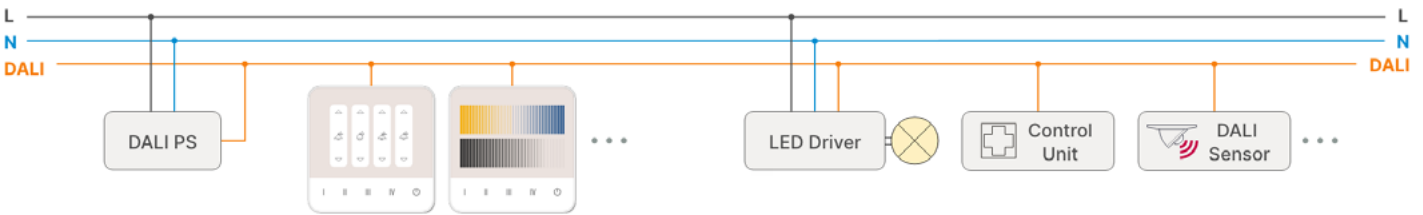

### Part numbering system:

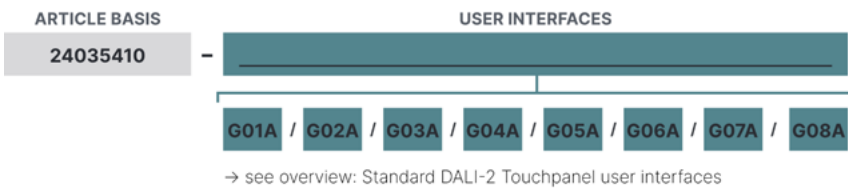

custom design?  
use our online configurator or send an inquiry to: [customlayout@lunatone.com](mailto:customlayout@lunatone.com)

### Standard DALI-2 Touchpanel user interfaces:

|   |   |   |  |
|---|---|---|--|
| <p><b>G01A</b></p> <p><b>Art. Nr.: 24035410-G01A</b><br/>Function: 1 brightness slider, arrow keys for fine adjustment<br/>Menu bar: 4 scenes, on / off</p> | <p><b>G02A</b></p> <p><b>Art. Nr.: 24035410-G02A</b><br/>Function: 4 groups on / off and dimmable with respective arrow keys<br/>Menu bar: 4 scenes, on / off</p> | <p><b>G03A</b></p> <p><b>Art. Nr.: 24035410-G03A</b><br/>Function: 1 brightness slider, 1 tunable white slider<br/>Menu bar: 4 scenes, on / off</p> | <p><b>G04A</b></p> <p><b>Art. Nr.: 24035410-G04A</b><br/>Function: 4 groups on / off, 1 brightness slider, 1 tunable white slider<br/>Menu bar: 4 scenes, on / off</p> |
|---|---|---|--|

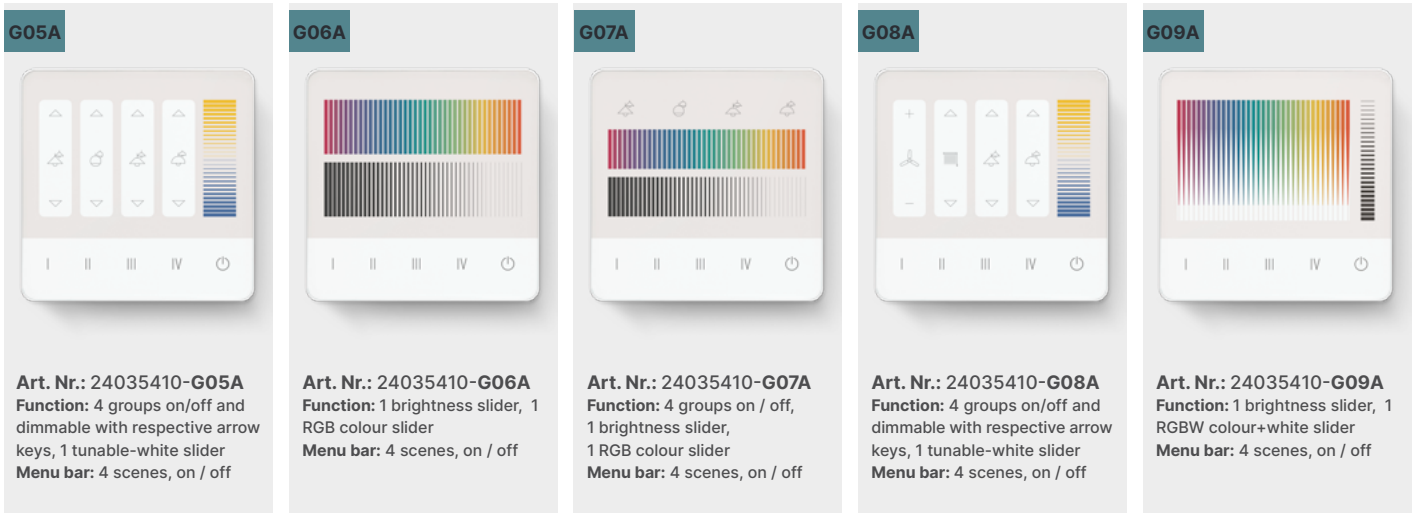

Overview DALI Cockpit – user interface configuration:

**Device Info**  
 Name: DALI2 Touch | Article Number: 24035465 | GTIN: 9010342013089  
 Manufacturer: Lunatone | Serial Number: 100  
 Device Type: - | Type: Control Device  
 DALI Ver: - | Short Address: (A0²) DALI2 Touch

**General** | Application | Instances

Buttons: Button 1, Button 2, Button 3, Button 4, Button 5, Button 6

**Button 1 Configuration:**  
 Button Center X [%]: 10 | Button Width [%]: 20  
 Button Center Y [%]: 25 | Button Height [%]: 60

**Destination Addresses:**  
 1: All (DALI Broadcast) | 2: none | 3: none | 4: none

**Function:**  
 BF1 - Pushbutton: sends CmdX  
 sending ON AND STEP UP as Start-Cmd

**Command X:** GOTO SCENE 0 | **Fade time:** Not used

**Callouts:**  
 - preview: position of the various buttons (points to preview image)  
 - settings for each button (max. 16 buttons) (points to button settings)  
 - selection of the effective range: broadcast, groups or individual addresses (points to destination addresses)  
 - button function: short press, long press, toggle, and many other functions (points to function dropdown)  
 - assigned commands: e.g. light intensity (%), dimming, max, min, scene 0-15, macros, etc. (points to command X dropdown)  
 - show/hide buttons/touch areas in the preview (top left) (points to Show buttons/Show touch area checkboxes)  
 - load image for the Touchpanel preview (top left) (points to Add picture button)  
 - delete button (points to Delete Button button)  
 - the button position is displayed in the preview (top left) (points to preview image)  
 - Devices can also be ordered with customer specific settings! (teal circle)

## DALI Touchpanel

The DALI Touchpanel is a multifunctional control unit with up to 12 freely configurable buttons. The operating panel can be customised and adjusted to any installation by replacing the paper inlay. Four layout cards are included in the scope of delivery. The number of buttons and the associated DALI commands can be set in the PC software DALI Cockpit. Each button can be individually configured with target address, button behaviour and DALI commands. In addition to the standard functions of dimming, switching, scene recall, etc., predefined macros such as setting the colour temperature, dynamic scenes and sequences, as well as user defined command lists are supported.



| NAME            | ARTICLE NUMBER | SUPPLY        | TYP. CURRENT CONSUMPTION DALI | DIMENSIONS (MM) |
|-----------------|----------------|---------------|-------------------------------|-----------------|
| DALI Touchpanel | 24035465       | via DALI line | 4mA                           | 111 × 83 × 9    |

### Installation example DALI Touchpanel



## DALI Bluetooth Interface

The DALI Bluetooth Interface allows the connection to the Lunatone Touch App available for iOS and Android devices via Bluetooth. Individual layouts and menus can be stored on [www.dalitouch.com](http://www.dalitouch.com) and shared with other users. The Bluetooth-devices have a reception range of about 10-15m.

### DALI Touch

Here you can download the app for your smartphone:



| NAME                         | ARTICLE NUMBER | SUPPLY        | TYP. CURRENT CONSUMPTION DALI | DIMENSIONS (MM) |
|------------------------------|----------------|---------------|-------------------------------|-----------------|
| DALI Bluetooth Interface 4.0 | 89453584       | via DALI line | 4mA                           | 59 × 33 × 15    |

### Typical setup for colour and colour temperature control:

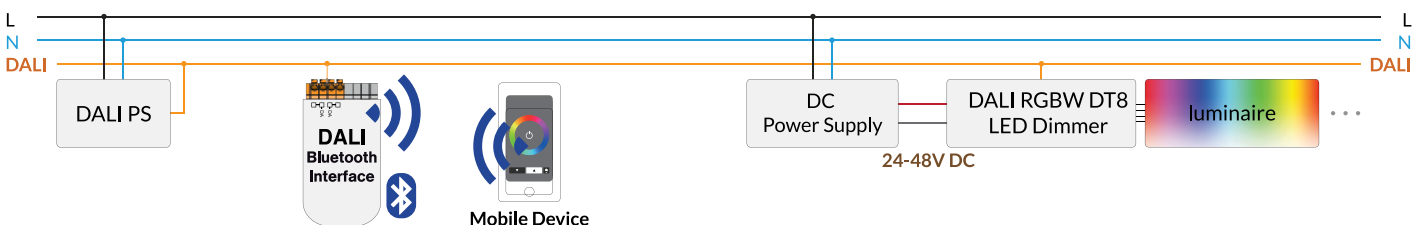

# DALI Touchpanel Bluetooth 4.0

The DALI Touchpanel is a multifunctional DALI control unit with up to 12 freely configurable buttons and Bluetooth connection to iOS and Android devices (DALI Touch App). Individual layouts and menus can be stored on [www.dalitouch.com](http://www.dalitouch.com) and shared with other users. The Bluetooth-devices have a reception range of about 10-15m.



## DALI Touch

Here you can download the app for your smartphone:



| NAME                          | ARTICLE NUMBER | SUPPLY        | TYP. CURRENT CONSUMPTION DALI | DALI TOUCH APP  | DIMENSIONS (MM) |
|-------------------------------|----------------|---------------|-------------------------------|-----------------|-----------------|
| DALI Touchpanel Bluetooth 4.0 | 24035465-BT    | via DALI line | 4mA                           | iOS und Android | 111 × 83 × 9    |

### Typical setup for colour and colour temperature control:

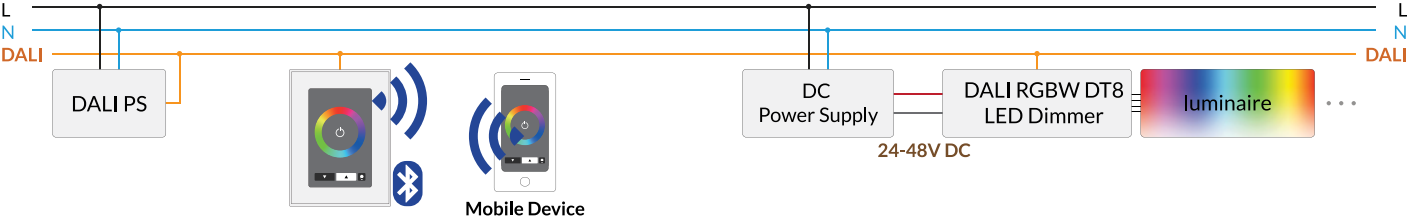

### Overview DALI Cockpit – user interface configuration:

Attention: save created functions!

DALI USB Interface

DALI Touchpanel

preview: position of the various buttons

tick this box to use the selected layout for the Touchpanel

select button command: e.g. light intensity (%), dimming, max, min, scene 0-15, macros, etc

add / delete button

enter button position

select effective range: broadcast, groups or individual addresses

define button function: e.g. press briefly, press and hold, toggle, etc. - various operating functions are available



# DALI-2 KNX Room Controller

The module enables commissioning, configuration and control of a DALI system via Bluetooth using the smartphone application DALI Cockpit Mobile.

The Lunatone smartphone application DALI Cockpit Mobile offers a clear and simple interface with a DALI installation assistant, various DALI configuration options and a configurable user interface to control connected DALI devices.

The module offers a KNX TP interface, which enables switching, dimming and scene control via KNX. Up to 8 gate functionalities can be implemented using the product database (ETS5/6). Each gate supports all DALI addressing types. Various KNX status objects are available for visualization.

The module has an integrated bus supply (200mA) for a DALI system of up to 64 DALI devices. The independent control gear is suitable for remote ceiling installation or integration in luminaires.



| NAME                           | ARTICLE NUMBER | INTERFACE            | INPUT SUPPLY CURRENT                            | OPERATING TEMPERATURE (TA) | DIMENSIONS (MM) |
|--------------------------------|----------------|----------------------|---|----------------------------|-----------------|
| DALI-2 BT5 Room Controller KNX | 87454427-KX    | DALI, KNX, Bluetooth | mains voltage 40mA (@120Vac),<br>20mA (@240Vac) | -10°C ... +55°C            | 159 × 42 × 22   |

## Installation example:

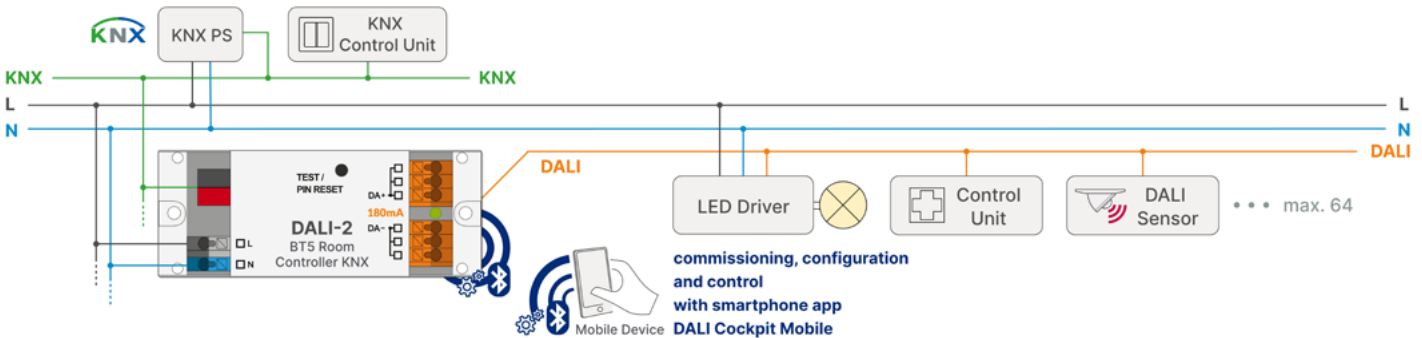

# DALI-2 Room Controller

The DALI-2 Room Controller serves as an interface between Bluetooth 5.0 and DALI. The device is ideal for room solutions. The supply as well as commissioning, configuration and control of a small DALI system can be easily implemented with this device.

The module has an integrated DALI bus supply (200mA) to operate up to 64 DALI devices. A connection to the Lunatone smartphone application DALI Cockpit Mobile can be established via the Bluetooth interface. The app offers a clear and simple user interface with an installation wizard, various configuration options and a customizable user interface to control connected devices.

The independent control gear is suitable for remote ceiling installation or integration in luminaires.





| NAME                       | ARTICLE NUMBER | INTERFACE       | INPUT SUPPLY CURRENT                            | OPERATING TEMPERATURE (TA) | DIMENSIONS (MM) |
|----------------------------|----------------|-----------------|---|----------------------------|-----------------|
| DALI-2 BT5 Room Controller | 87454427       | DALI, Bluetooth | mains voltage 40mA (@120Vac),<br>20mA (@240Vac) | -20°C ... +75°C            | 120 × 41 × 22   |

Installation example:

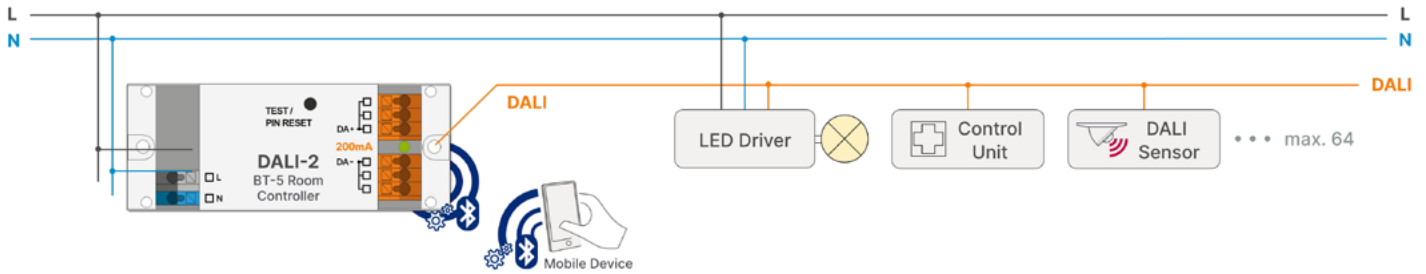

# DALI Cockpit Mobile - Smartphone application

Smartphone application for easy setup and configuration of DALI systems in connection with the DALI-2 BT5 Room Controller. The DALI system can be addressed, configured and controlled

via the app. In addition, a customizable user interface can be created for light control via mobile phone.



customizable user interface for light control

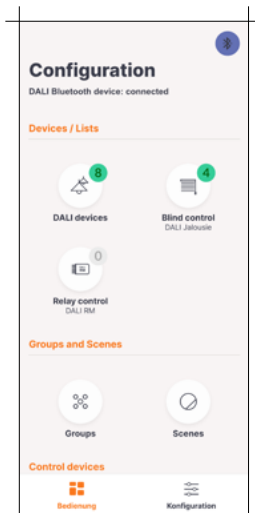

menu with various sub-items for device configuration

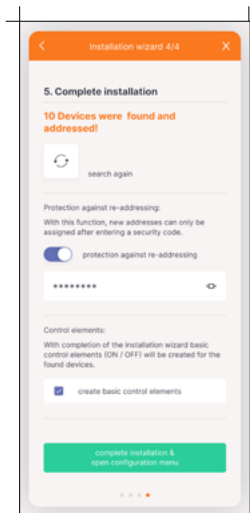

installation assistant for device addressing

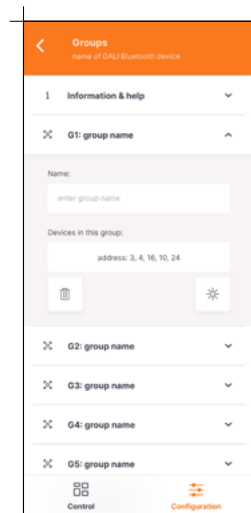

configuration page for DALI groups

## DALI Cockpit Mobile

Here you can download the app for your smartphone:



settings page of push button coupler - DALI-2 MC4L



settings page of push & rotary switch - DALI-2 ROT

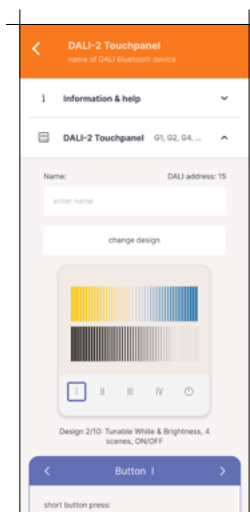

settings page for DALI-2 Touchpanel

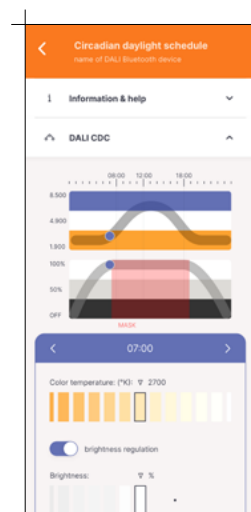

settings page for circadian daylight schedule - DALI CDC

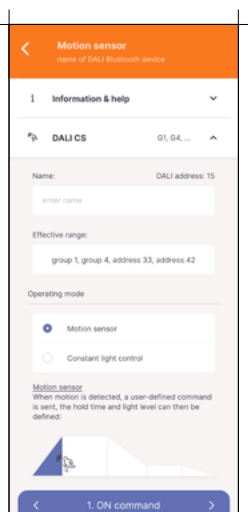

settings page of motion sensor DALI-2 CS

# DALI ROT

Fast and precise control with a traditional push and rotary knob. The device is powered by the DALI bus. Target address(es), button behaviour and DALI commands can be configured with the PC software DALI Cockpit. All standard DALI commands, such as dimming, switching, scene recall, etc. are supported. Furthermore, versions for Tunable White, RGB and RGBW control are available, enabling the change of colour temperature or colour by turning the rotary knob. DALI ROT covers and knobs are available in white and black. Furthermore, the module can be combined with covers from third-party suppliers (the shaft is Ø4 mm, an adapter for Ø6mm is included in the scope of delivery). Customer specific designs can be implemented upon request.



| NAME       | ARTICEL NUMBER | INPUT TYPE | TYP. CURRENT CONSUMPTION DALI | OPERATING TEMPERATURE (TA) | MOUNTING                          | DIMENSIONS (MM) |
|------------|----------------|------------|-------------------------------|----------------------------|-----------------------------------|-----------------|
| DALI-2 ROT | 86459822-__    | DALI       | typ. 1.6mA (at 16,5V)         | -20°C ... 75°C             | for flush-type installation boxes | 70 × 70 × 45    |

**Installation example:**

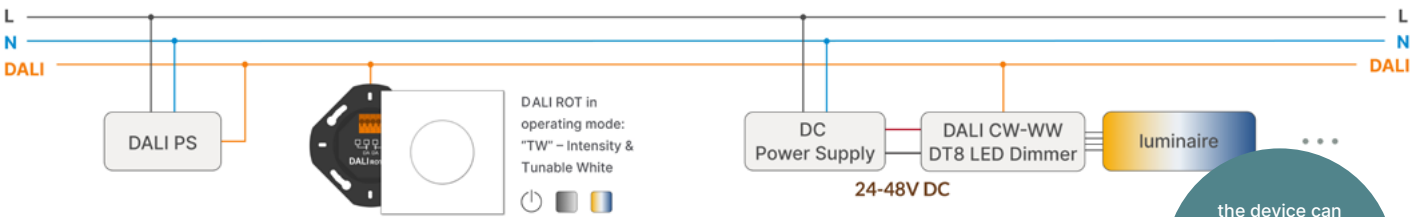

the device can send commands to the entire DALI bus, to groups, or to individual addresses

**Part numbering system:**

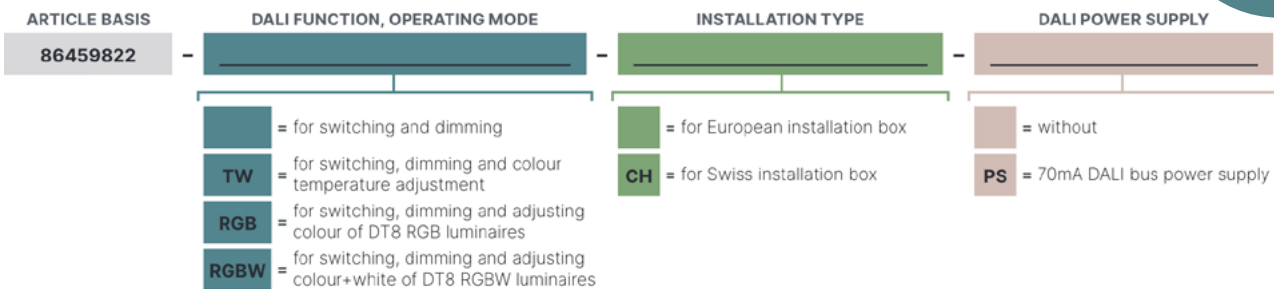

**Supported operating modes:**

|   |  |   |  |
|---|--|---|--|
| <p><b>operating mode 1</b><br/><b>Intensity Switch / Dim</b></p> <p>press: ON / OFF<br/>rotate: dim up / down</p> | <p><b>TW</b> <b>operating mode 2:</b><br/><b>Intensity &amp; Tunable White</b></p> <p>short press: ON / change MODE<br/>long press: OFF<br/>mode 1 - rotate: dim up / down<br/>mode 2 - rotate: colour temperature</p> | <p><b>RGB</b> <b>operating mode 3:</b><br/><b>Intensity &amp; RGB</b></p> <p>short press: ON / change MODE<br/>long press: OFF<br/>mode 1 - rotate: dim up / down<br/>mode 2 - rotate: colour (RGB)</p> | <p><b>RGBW</b> <b>operating mode 4:</b><br/><b>Intensity &amp; RGBW</b></p> <p>short press: ON / change MODE<br/>long press: OFF<br/>mode 1 - rotate: dim up / down<br/>mode 2 - rotate: colour (RGB)<br/>mode 3 - rotate: white channel</p> |
|---|--|---|--|

Installation type:

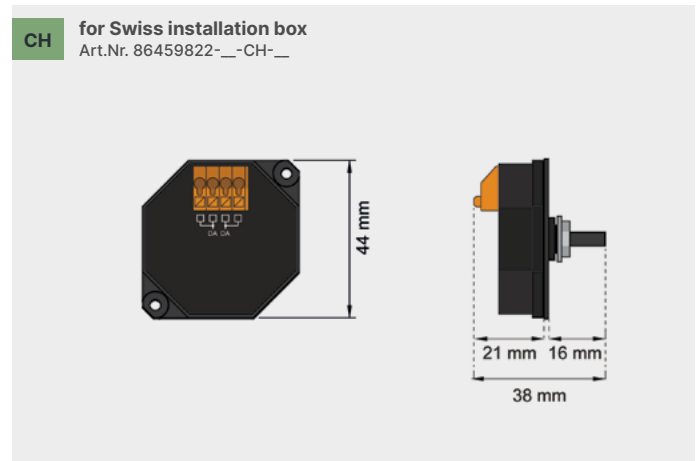
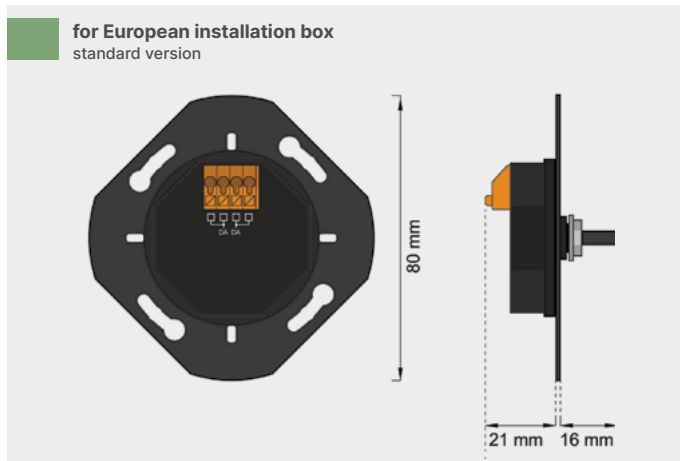

Power supply:

With the output current of up to 70mA a small DALI installation can be supplied. The device is attached to the back of the DALI-2 ROT device. Up to 3 DALI-2 ROTs with power supply can be used in one DALI line. The polarity of the DALI connections must be considered.

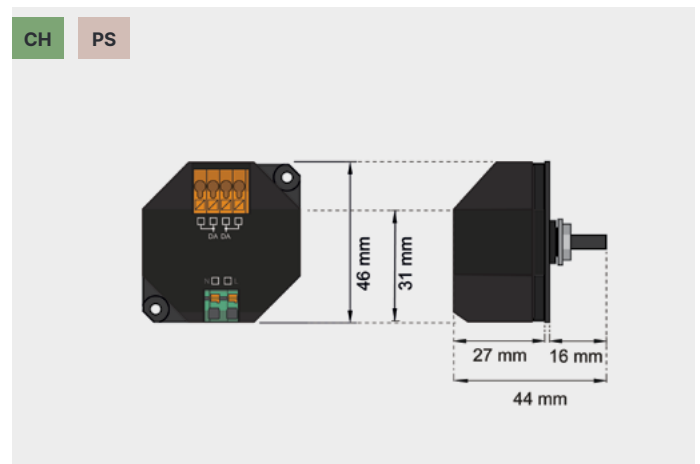
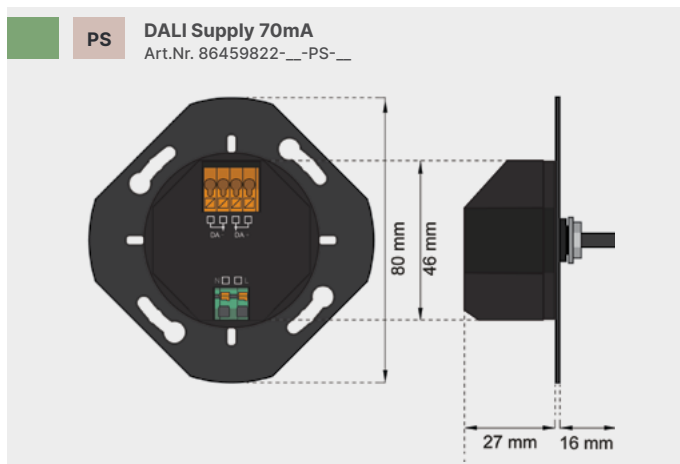

Accessories:

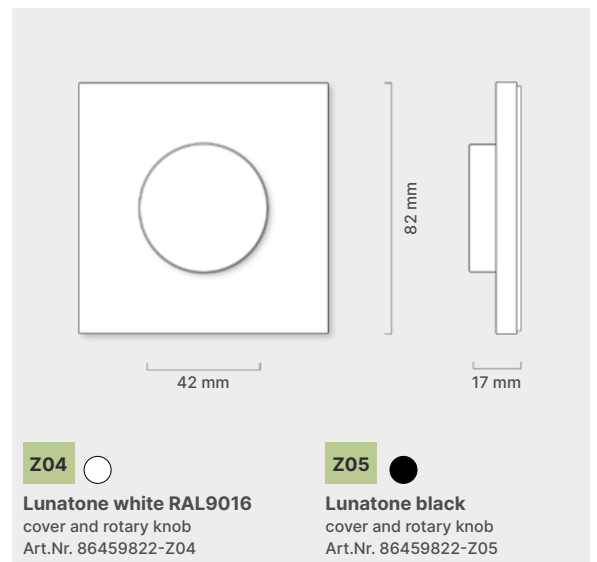
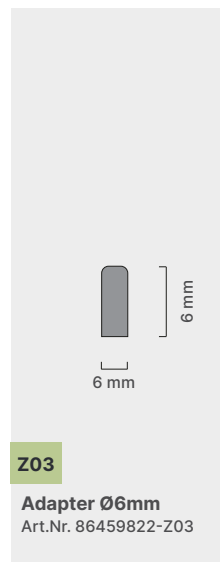
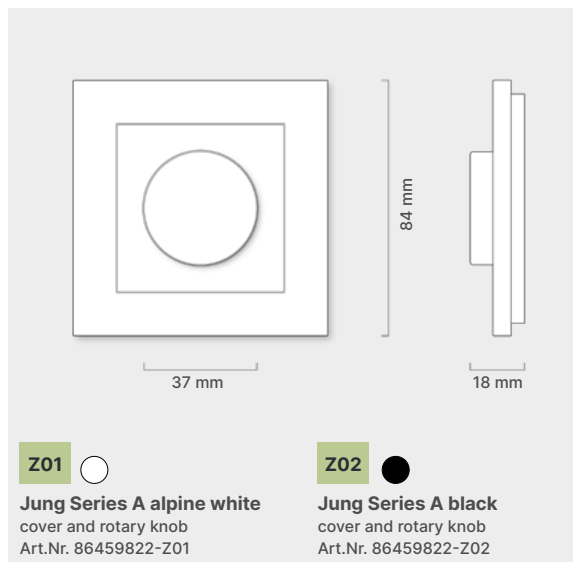

# DALI-2 ROT

Rotary and push button with DALI output for fast and precise control of brightness, colour, or colour temperature. All standard functions such as dimming, switching, scene recall, etc. are supported.

The PC software DALI Cockpit can be used to set the operating mode, effective range and individual DALI commands for the push button and rotary knob.

The standard device has an application controller, but can be set to instance mode as well. The module "-D2" only supports the instance mode (sending event messages instead of direct control commands) for integration in higher-level building management systems with DALI connection, such as from WAGO or Beckhoff. The device can be mounted on commercially available flush-type installation boxes. It is directly supplied by the DALI line. DALI-2 ROT covers and knobs are available in white and black. Furthermore, the module can be combined with covers from third-party suppliers (the shaft is Ø4 mm, an adapter for Ø6mm is included in the scope of delivery). Customer specific designs



can be implemented upon request.

The module "-NFC" supports the adjustment of selected settings via smartphone (NFC capable) with the Lunatone NFC Android app, in addition to the configuration via the DALI Cockpit.

| NAME       | ARTICEL NUMBER | INPUT TYPE | CURRENT CONSUMPTION DALI                     | OPERATING TEMPERATURE (TA) | MOUNTING                          | DIMENSIONS (MM) |
|------------|----------------|------------|--|----------------------------|-----------------------------------|-----------------|
| DALI-2 ROT | 86459822-__    | DALI       | typ. 1.6mA (at 16,5V)<br>max. 5mA (at 22,5V) | -20°C ... 75°C             | for flush-type installation boxes | 70 × 70 × 45    |

Overview DALI Cockpit, settings tab "General" :

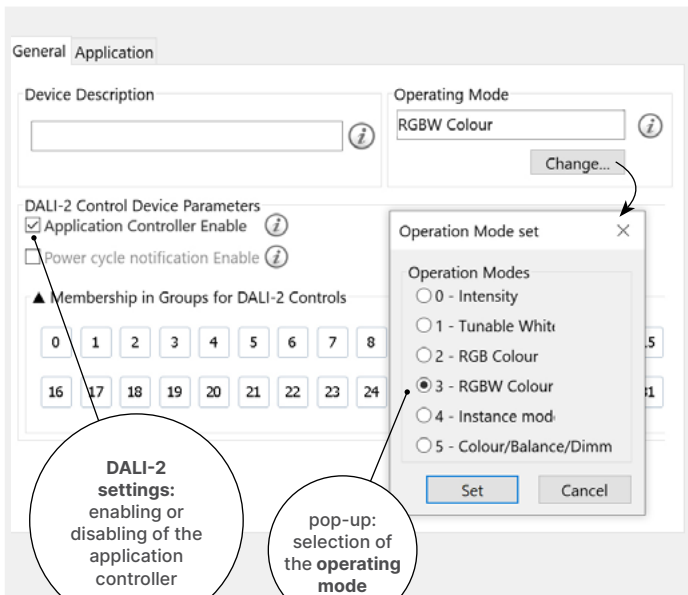

Overview DALI Cockpit, settings tab "Application":

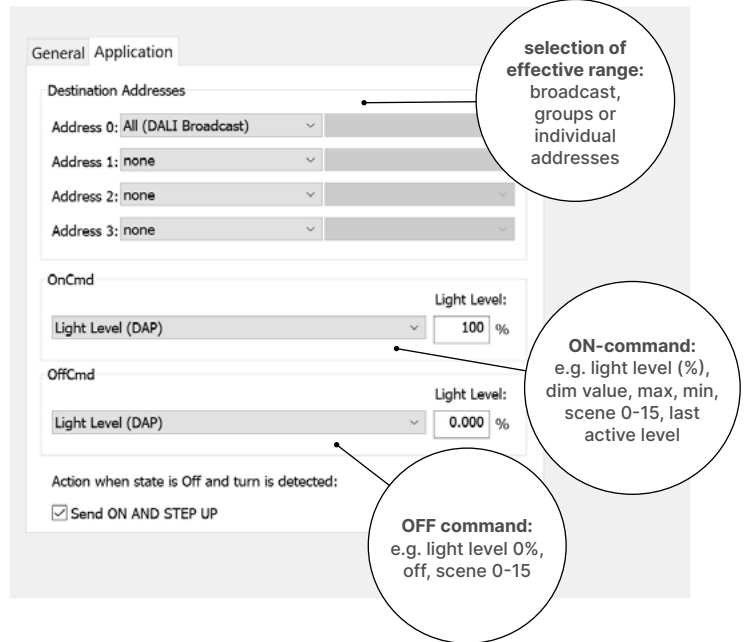

Installation example:

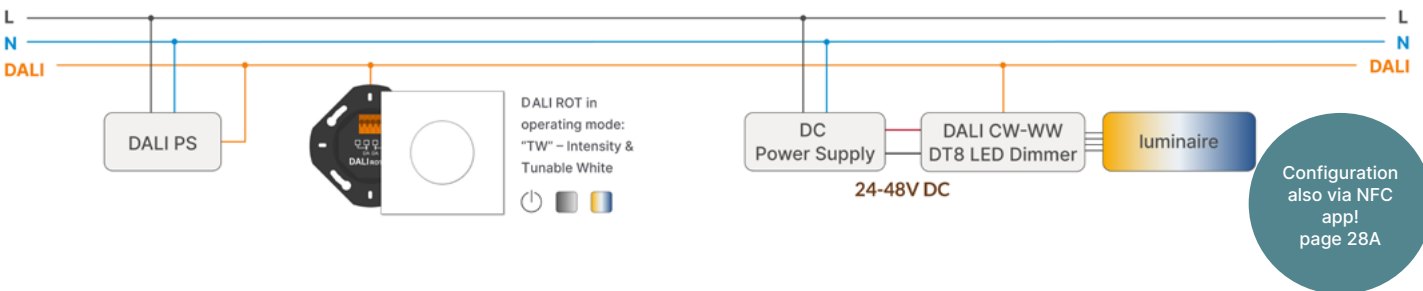

Part numbering system:



Supported operating modes:

**NFC** operating mode 1 - default setting:  
"I" - Intensity: Switch / Dim

ON/OFF      DIM

press: ON / OFF  
rotate: dim up / down

**NFC** operating mode 2:  
"TW" - Intensity & Tunable White

ON/change mode      OFF      mode 1 DIM      mode 2 CW-WW

short press: ON / change mode, long press OFF  
mode 1 rotate: dimming, mode 2 rotate: colour temp.

**NFC** operating mode 3:  
"RGB" - Intensity & RGB

ON/change mode      OFF      mode 1 DIM      mode 2 RGB

short press: ON / change mode, long press OFF  
mode 1 rotate: dimming, mode 2 rotate: colour

**NFC** Operating mode 4:  
"RGBW" - Intensity & RGBW

ON/change mode      OFF      mode 1 DIM      mode 2 RGB      mode 3 White

short press: ON / change mode, long press OFF  
mode 1 rotate: dimming, mode 2 rotate: colour, mode 3 rotate: white channel

**NFC** operating mode 5:  
"D2I" - DALI-2 Instanzmodus

**D2**

instance type 0      instance type 1

press: instance 0, push button  
rotate: instance 1, generic, event messages for:  
"start rotate clockwise", "start rotate counterclockwise", "stop rotate"

**NFC** operating mode 6:  
"BD/CD" - Balance&Dim/Colour&Dim

ON/change mode      OFF      mode 1 DIM      mode 2 TW/RGB

short press: ON / change mode, long press OFF  
mode 1 rotate: dimming, mode 2 rotate: colour/colour temperature

Installation type:

**E** for European installation box  
standard version

60 mm      70 mm

**CH** for Swiss installation box  
Art.Nr. 86459822-\_\_-CH-\_\_

44 mm      52 mm

Power supply:

**PS** DALI Supply 70mA  
Art.Nr. 86459822-\_\_-PS-\_\_

With the output current of up to 70mA a small DALI installation can be supplied. The device is attached to the back of the DALI-2 ROT device. Up to 3 DALI-2 ROTs with power supply can be used in one DALI line. The polarity of the DALI connections must be considered.

DIMENSIONS see DALI ROT

Accessories:

**Z01** Jung Series A alpine white cover and rotary knob  
Art.Nr. 86459822-Z01

**Z02** Jung Series A black cover and rotary knob  
Art.Nr. 86459822-Z02

**Z03** Adapter Ø6mm  
Art.Nr. 86459822-Z03

**Z04** Lunatone white RAL9016 cover and rotary knob  
Art.Nr. 86459822-Z04

**Z05** Lunatone black cover and rotary knob  
Art.Nr. 86459822-Z05

# DALI-2 ROT Touch

Rotary and push button with capacitive sensor buttons for quick and precise control of brightness, colour, or colour temperature. Functionality and effective range for the rotary pushbutton can be set with the 3 or 5 capacitive buttons. The capacitive button will light up after being pressed to indicate the selected mode, the rotary knob will then control for example colour, brightness, etc. Furthermore, it is possible to send individual DALI commands via the capacitive buttons to e.g., recall a scene. Several standard user interfaces are available and customer specific designs can be implemented upon request.

In addition to configuration via the PC software DALI Cockpit, selected settings can also be made using an NFC-enabled smartphone and the Lunatone NFC Android app.

The device can be mounted on commercially available flush-type installation boxes. It is directly supplied by the DALI line. A version with DALI bus power supply (-PS) is also available.

The -INT module is set to instance mode as delivery default (sending event messages instead of direct control commands) for integration in higher-level building management systems with DALI connection, such as those from WAGO or Beckhoff.

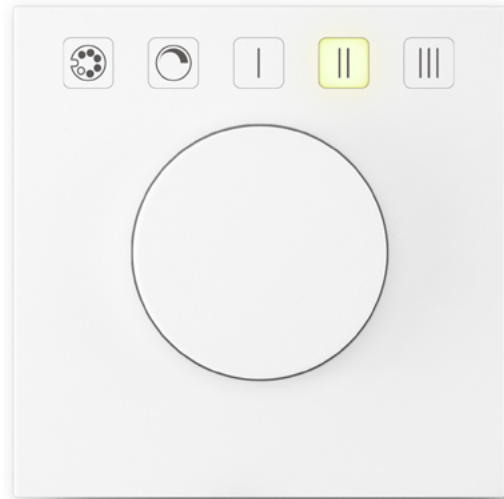

| NAME             | ARTICEL NUMBER | INPUT TYPE | CURRENT CONSUMPTION DALI                     | OPERATING TEMPERATURE (TA) | MOUNTING                          | DIMENSIONS (MM) |
|------------------|----------------|------------|--|----------------------------|-----------------------------------|-----------------|
| DALI-2 ROT Touch | 86459338-__    | DALI       | typ. 1.6mA (at 16,5V)<br>max. 5mA (at 22,5V) | -20°C ... 75°C             | for flush-type installation boxes | 70 × 70 × 45    |

**Part numbering system:**

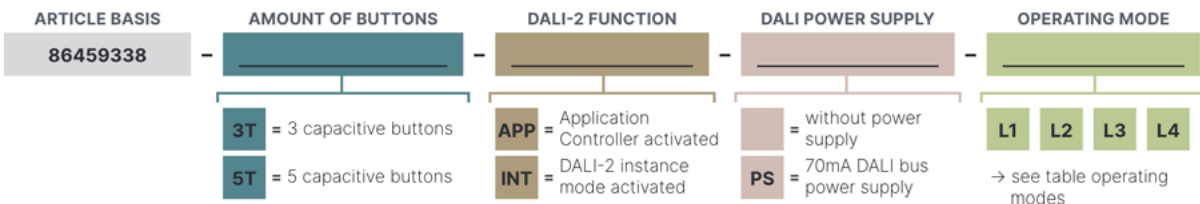

Customer-specific designs can be implemented upon request! customlayout@lunatone.com

**Operating modes:**

**Layout with 3 buttons -3T**

**Layout with 5 buttons -5T**

| Operating Mode  | 3T Buttons                 | 5T Buttons                                   |
|---|----------------------------|--|
| <b>L1</b><br>Scenes & groups<br>Art.Nr.: 86459338-__-L1         | scene 1, scene 2, group 0  | scene 1, scene 2, scene 3, group 0, group 1  |
| <b>L2</b><br>Scenes, groups & blinds<br>Art.Nr.: 86459338-__-L2 | scene 1, group 0, blinds   | scene 1, scene 2, group 0, group 1, blinds   |
| <b>L3</b><br>Tunable white & scenes<br>Art.Nr.: 86459338-__-L3  | CW-WW, brightness, scene 1 | CW-WW, brightness, scene 1, scene 2, scene 3 |
| <b>L4</b><br>Colour & scenes<br>Art.Nr.: 86459338-__-L4         | RGB, brightness, scene 1   | RGB, brightness, scene 1, scene 2, scene 3   |

# DALI-2 Switch Cross NFC

Pushbutton module with four programmable buttons. With the PC software DALI Cockpit, each button can be individually configured with target address, button behaviour and DALI commands. In addition to the standard functions of dimming, switching, scene recall, etc., predefined macros such as setting the colour temperature, dynamic scenes and sequences, as well as user defined command lists are supported. Several flexible standard layouts with respective presets such as light & blinds are available. Custom layouts can be implemented upon request.

The device can be ordered with factory setting "application controller" or "instance mode". The factory setting can be changed with the PC software DALI Cockpit or Lunatone NFC App (module "-NFC"). When used as "application controller" the device sends direct control commands. In "Instance" mode only event messages are sent for integration in higher-level building management systems with DALI connection, such as those from WAGO or Beckhoff.

The module "-NFC" supports the adjustment of selected settings



image (from left to right): RAL9010; RAL9016; black



via smartphone (NFC capable) with the Lunatone NFC Android app, in addition to the configuration via the DALI Cockpit.

| NAME                | ARTICEL NUMBER | INTERFACE | SUPPLY        | CURRENT CONSUMPTION DALI                     | MOUNTING                          | DIMENSIONS (MM) |
|---------------------|----------------|-----------|---------------|--|-----------------------------------|-----------------|
| DALI-2 Switch Cross | 86459793-__    | DALI      | via DALI line | typ. 1.7mA (at 16,5V)<br>max. 2mA (at 22,5V) | for flush-type installation boxes | 8,5 × 82 × 82   |

### Part numbering system:

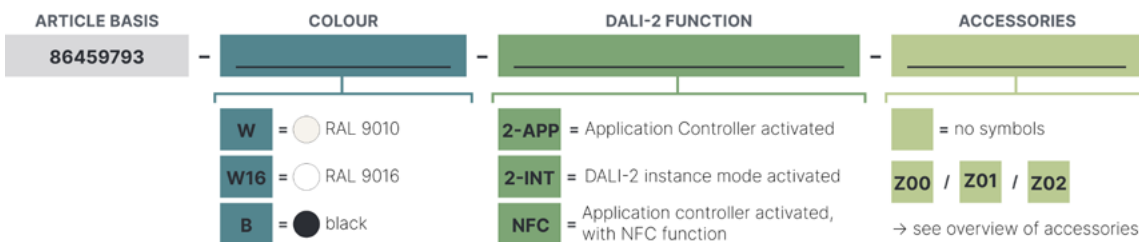

### Installation example Art.Nr.: 86459793-\_\_-NFC

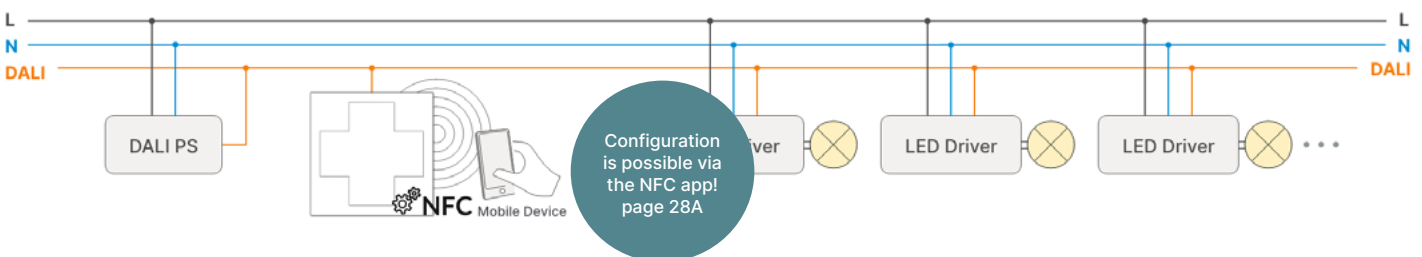

### Accessories:

**Z00**

Individual design?  
Use our online configurator or send an inquiry to: [customlayout@lunatone.com](mailto:customlayout@lunatone.com)

**Cross plate with customer specific symbols**  
Art.Nr. 86459793-\_\_-Z00

**Z01**

**Cross plate with symbols for dimming**  
Art.Nr. 86459793-\_\_-Z01

**Z02**

**Cross plate with symbols for dimming and blind control**  
Art.Nr. 86459793-\_\_-Z02

37 mm

84 mm



# wDALI Switch Cross

This multifunctional DALI control module is wirelessly connected to the DALI line, via a transceiver. The switch is battery powered and can be mounted anywhere within the reception range of the transceiver, without great installation effort. Each button can be individually configured with target address, button behaviour and DALI commands. Beside the standard functions: dimming, switching, scene recall, etc., predefined macros such as setting the colour temperature, dynamic scenes and sequences as well as user defined command lists are also supported. The control buttons can be labeled with different symbols.



| NAME   | ARTICLE NUMBER | COLOUR           | SUPPLY        | CURRENT CONSUMPTION DALI TRANSCEIVER | FREQUENCY RANGE | DIMENSIONS (MM)               |
|--|----------------|------------------|---------------|--------------------------------------|-----------------|-------------------------------|
| wDALI Switch Cross white incl. Transceiver   | 86459541-W+T   | ○ white, RAL9010 | Battery*      | typ. 3,8mA                           | 2,4GHz          | 8,5 × 82 × 82<br>59 × 33 × 15 |
| wDALI Switch Cross RAL9016 incl. Transceiver | 86459541-W16+T | ○ white, RAL9016 | Battery*      | typ. 3,8mA                           | 2,4GHz          | 8,5 × 82 × 82<br>59 × 33 × 15 |
| wDALI Switch Cross black incl. Transceiver   | 86459541-B+T   | ● black          | Battery*      | typ. 3,8mA                           | 2,4GHz          | 8,5 × 82 × 82<br>59 × 33 × 15 |
| wDALI Transceiver                            | 86459587-TR    | grey             | via DALI line | typ. 3,8mA                           | 2,4GHz          | 59 × 33 × 15                  |
| wDALI Switch Cross white excl. Transceiver   | 86459541-W     | ○ white, RAL9010 | Battery*      | excl. Transceiver                    | 2,4GHz          | 8,5 × 82 × 82                 |
| wDALI Switch Cross RAL9016 excl. Transceiver | 86459541-W16   | ○ white, RAL9016 | Battery*      | excl. Transceiver                    | 2,4GHz          | 8,5 × 82 × 82                 |
| wDALI Switch Cross black excl. Transceiver   | 86459541-B     | ● black          | Battery*      | excl. Transceiver                    | 2,4GHz          | 8,5 × 82 × 82                 |

\*Battery type CR2032, average lifespan ~ 10000 acutations, within 10 years

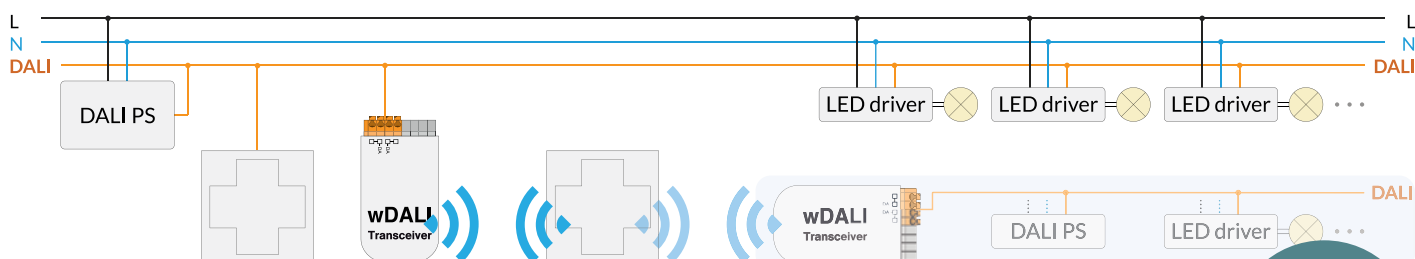

## Accessories:

**Z00**

Individual design?  
Use our online configurator or send an inquiry to:  
customlayout@lunatone.com

**Z01**

**Cross plate with symbols for dimming**

Art.Nr. 86459793-\_-Z01  
Art.Nr. 86459541-\_-Z01

**Z02**

**Cross plate with symbols for dimming and blind control**

Art.Nr. 86459793-\_-Z02  
Art.Nr. 86459541-\_-Z02

One wDALI switch can connect to multiple wDALI transceivers!

## wDALI Switch Cross accessories: thin plate to stick on at the desired mounting position

| NAME                                 | ARTICLE NUMBER  | COLOUR |
|--------------------------------------|-----------------|--------|
| Mounting plate white (for W and W16) | 86459541-W16-MP | ○      |
| Mounting plate black                 | 86459541-B-MP   | ●      |

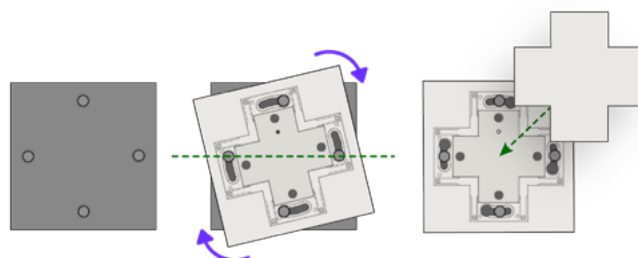

# wDALI Remote

A remote control for DALI systems with 12 buttons. This remote control enables location independent control of a DALI system (light, blinds, ventilators, ...). The device communicates wirelessly with a transceiver that is connected to the DALI bus. Each button can be individually configured with target address, button behaviour and DALI commands. Beside the standard functions, dimming, switching, scene recall, etc., predefined macros such as setting the colour temperature, dynamic scenes and sequences as well as user defined command lists are also supported. The device is multi-master compliant and allows the usage of multiple control modules on the DALI line. The control buttons can be labeled with different symbols.



| NAME                                 | ARTICLE NUMBER | COLOUR           | SUPPLY        | CURRENT CONSUMPTION DALI TRANSCEIVER | FREQUENCY RANGE | DIMENSIONS (MM)               |
|--------------------------------------|----------------|------------------|---------------|--------------------------------------|-----------------|-------------------------------|
| wDALI Remote white incl. Transceiver | 86459534-W+T   | ○ white, RAL9010 | Battery*      | typ. 3,8mA                           | 2,4GHz          | 140 × 52 × 10<br>59 × 33 × 15 |
| wDALI Remote black incl. Transceiver | 86459534-B+T   | ● black          | Battery*      | typ. 3,8mA                           | 2,4GHz          | 140 × 52 × 10<br>59 × 33 × 15 |
| wDALI Transceiver                    | 86459587-TR    | grey             | via DALI line | typ. 3,8mA                           | 2,4GHz          | 59 × 33 × 15                  |
| wDALI Remote white excl. Transceiver | 86459534-W     | ○ white, RAL9010 | Battery*      | excl. Transceiver                    | 2,4GHz          | 140 × 52 × 10                 |
| wDALI Remote black excl. Transceiver | 86459534-B     | ● black          | Battery*      | excl. Transceiver                    | 2,4GHz          | 140 × 52 × 10                 |

\*Battery type CR2032, average lifespan ~ 10000 acutations, within 10 years

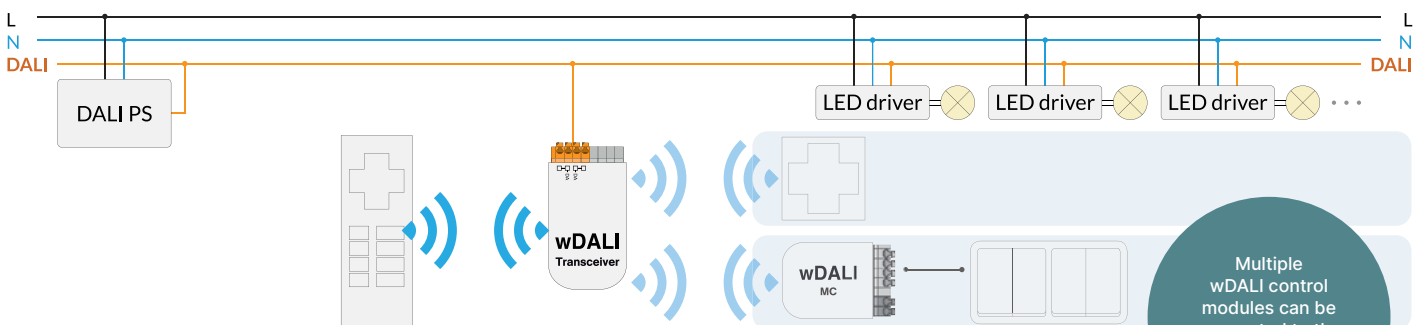

## FACTORY SETTING:

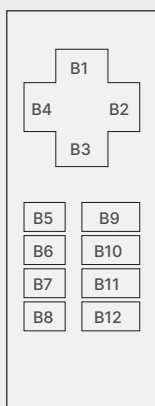

### PRESET 1 (FACTORY DEFAULT):

#### SWITCH & DIM

- B1: on (maximum)
- B3: off
- B4 long press: dim down
- B2 long press: dim up
- B5-B8: on/off group 0 (B5) to group 3 (B8)
- B9-B12: on/off Scene 0 (B9) to scene 3 (B12)

### PRESET 2:

#### SWITCH, DIM & COLOUR TEMPERATURE

- B1: on / maximum
- B1 long press: dim up
- B3: off
- B3 long press: dim down
- B4 long press: colder
- B2 long press: warmer
- The buttons B5-B12 are the same as in FACTORY SETTING 1

## wDALI MC - wireless pushbutton coupler

wDALI MC is a wireless version of the DALI MC module. The battery powered wDALI MC module has four pushbutton inputs. Each input can be individually configured with target address, button behaviour and DALI commands. The device can be mounted anywhere within the reception range of the transceiver. The reception range in buildings is usually 10-20m.

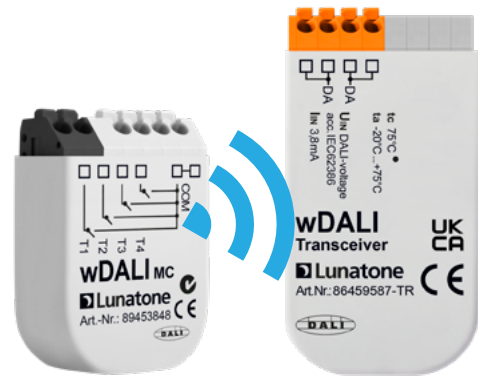

| NAME                      | ARTICEL NUMBER | SUPPLY        | CURRENT CONSUMPTION DALI TRANSCEIVER | OPERATING TEMPERATURE (TA) | FREQUENCY RANGE | DIMENSIONS (MM)              |
|---------------------------|----------------|---------------|--------------------------------------|----------------------------|-----------------|------------------------------|
| wDALI MC with Transceiver | 89453848+T     | Battery*      | typ. 3,8mA                           | -20°C - +75°C              | 2,4GHz          | 40 × 28 × 15<br>59 × 33 × 15 |
| wDALI MC                  | 89453848       | Battery*      | excl. Transceiver                    |                            | 2,4GHz          | 40 × 28 × 15                 |
| * extra Transceiver       | 86459587-TR    | via DALI line | typ. 3,8mA                           | -20°C - +75°C              | 2,4GHz          | 59 × 33 × 15                 |

\*Battery type CR2032, average lifespan ~ 10000 acutations, within 10 years

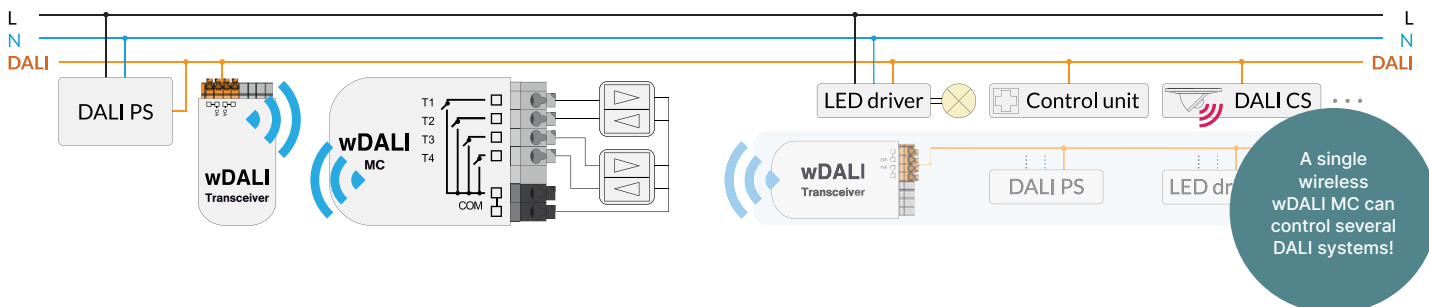

## DALI-2 MC - pushbutton coupler

Pushbutton coupler with 4 inputs to connect standard potential free switches or pushbuttons. Each input can be individually configured with target address, button behaviour and DALI commands. In addition to the standard functions of dimming, switching, scene recall, etc., predefined macros such as setting the colour temperature, dynamic scenes, and sequences, as well as user defined command lists are supported. The device can be ordered with factory setting "application controller" or "instance mode". The factory setting can be changed with the PC software DALI Cockpit or Lunatone NFC app (module "-NFC"). When used as "application controller" the device sends direct control commands. In "Instance" mode only event messages are sent for integration in higher-level building management systems with DALI connection, such as those from WAGO or Beckhoff.

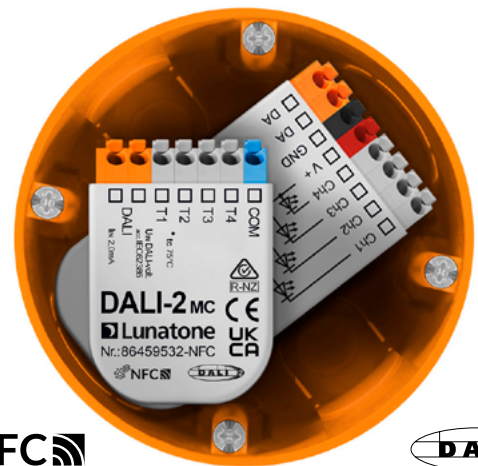

The DALI-2 MC NFC supports the adjustment of selected settings via smartphone (NFC capable) with the Lunatone NFC Android app, in addition to the configuration via the DALI Cockpit. The device is designed to fit behind a switch in a flush-type installation box.

| NAME          | ARTICEL NUMBER | FACTORY SETTING   | NFC | SUPPLY        | OPERATING TEMPERATURE (TA) | DIMENSIONS (MM) |
|---------------|----------------|---|-----|---------------|----------------------------|-----------------|
| DALI-2 MC     | 86459532-2-app | application controller activated  | no  | via DALI line | -20°C ... +75°C            | 40 × 28 × 15    |
| DALI-2 MC     | 86459532-2-int | instance mode activated   | no  | via DALI line | -20°C ... +75°C            | 40 × 28 × 15    |
| DALI-2 MC NFC | 86459532-NFC   | application controller activated,<br>Android app DALI NFC for configuration | yes | via DALI line | -20°C ... +75°C            | 40 × 28 × 15    |

Installation example Art. Nr.: 86459532-NFC

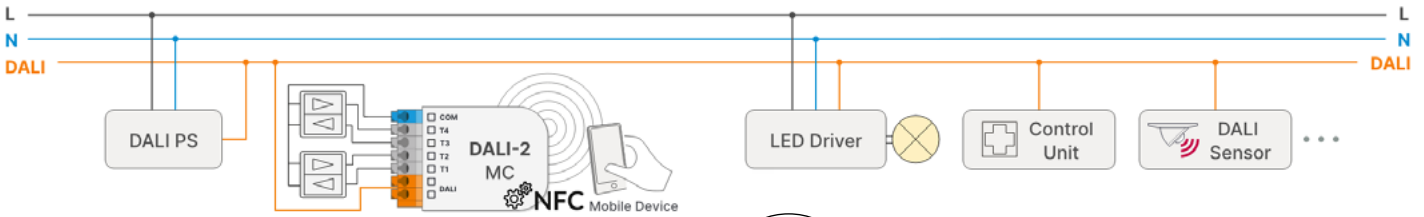

The screenshot shows the DALI Cockpit software interface for configuring a DALI-2 MC module. Callouts provide the following information:

- selection of effective range:** broadcast, groups or individual addresses
- button function:** short press, long press, toggle and many other functions
- settings for each input**
- alternative configuration can be activated and deactivated with scene commands or input 4**
- interpretation of scene command for toggle functions**
- assigned commands:** e.g. light intensity (%), dimming, max, min, scene 0-15, macros, etc.

The interface shows configuration for Input 1, including destination addresses, function (BF6 - Dim button), and command settings (Command X: Light Level (DAP), Command Y: RECALL MIN LEVEL).

## DALI-2 MC1L - pushbutton coupler

DALI-2 control module with a switching input for mains voltage that is galvanically isolated from the DALI bus. The input can be individually configured with target address, button behaviour and DALI command. Besides the standard functions, dimming, switching, scene recall, etc., predefined macros such as setting the colour temperature, dynamic scenes and sequences as well as user defined command lists are supported. In addition DALI DT8 TC and RGB(W) control is also supported.

Factory setting: the application controller is activated (can be set to instance mode with the PC software DALI Cockpit).



The device is designed to fit behind a switch in a flush-type installation box.

| NAME        | ARTICEL NUMBER | FACTORY SETTING                  | SUPPLY        | DALI CURRENT CONSUMPTION | INPUT    | DIMENSIONS (MM) |
|-------------|----------------|----------------------------------|---------------|--------------------------|----------|-----------------|
| DALI-2 MC1L | 86458507-1L-2  | application controller activated | via DALI line | typ. 4,6mA               | 1 × 230V | 59 × 33 × 15    |

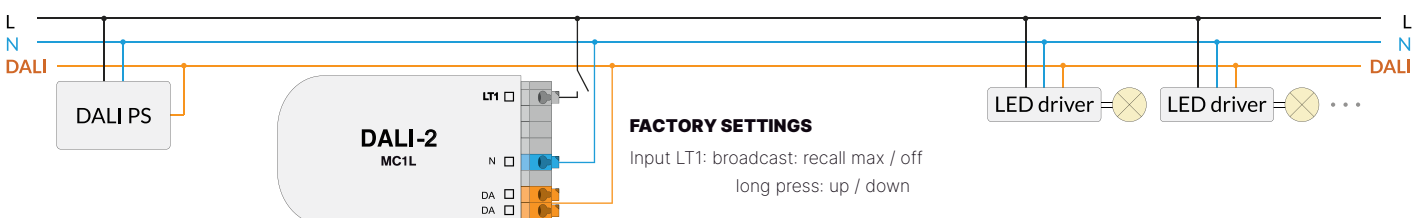

# DALI-2 MC4L - pushbutton coupler

DALI-2 control module with four switching inputs for mains voltage that are galvanically isolated from the DALI bus. Each input can be individually configured with target address, button behaviour and DALI command. Besides the standard functions, dimming, switching, scene recall, etc., predefined macros such as setting the colour temperature, dynamic scenes and sequences as well as user defined command lists are supported. The device can be ordered with the factory setting "Application Controller" or "Instance mode". A change is possible with the PC software DALI Cockpit or, with the NFC version, via the DALI NFC Android app.



| NAME                 | ARTICLE NUMBER       | FACTORY SETTING  | NFC | SUPPLY        | DALI CURRENT CONSUMPTION | INPUT    | DIMENSIONS (MM) |
|----------------------|----------------------|--|-----|---------------|--------------------------|----------|-----------------|
| DALI-2 MC4L          | 86458507-4L-2-app    | application controller activated                                     | no  | via DALI line | typ. 1,7mA               | 4 × 230V | 59 × 33 × 15    |
| DALI-2 MC4L          | 86458507-4L-2-int    | instance mode activated  | no  | via DALI line | typ. 1,7mA               | 4 × 230V | 59 × 33 × 15    |
| DALI-2 MC4L          | 86458507-4L-NFC      | application controller activated<br>Android app DALI NFC for config. | yes | via DALI line | typ. 1,7mA               | 4 × 230V | 59 × 33 × 15    |
| DALI-2 MC4L DIN rail | 86458507-4L-HS-2-app | application controller activated                                     | no  | via DALI line | typ. 1,7mA               | 4 × 230V | 98 × 17,5 × 57  |
| DALI-2 MC4L DIN rail | 86458507-4L-HS-2-int | instance mode activated  | no  | via DALI line | typ. 1,7mA               | 4 × 230V | 98 × 17,5 × 57  |

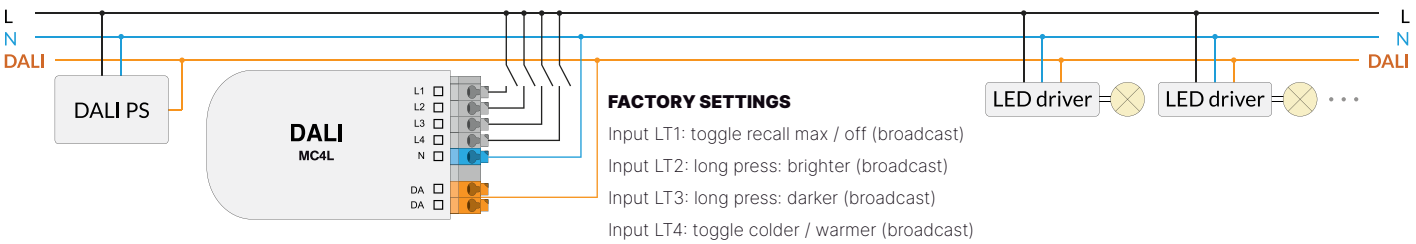

# DALI-2 MC1L PS, MC2L PS

Interface with one or two switching inputs for mains voltage that are galvanically isolated from the DALI bus. Each input can be individually configured with target address, button behaviour and DALI commands. Besides the standard functions, dimming, switching, scene recall, etc., predefined macros such as setting the colour temperature, dynamic scenes and sequences as well as user defined command lists are supported. In addition DALI DT8 TC and RGB(W) control is also supported.

Factory setting: the application controller is activated (can be set to



instance mode with the PC software DALI Cockpit). The device is designed to fit behind a switch in a flush-type installation box. The device has an integrated bus power supply (50mA).

| NAME           | ARTICLE NUMBER | FACTORY SETTING                  | STROMSUPPLY                    | INTEGRATED DALI BUS SUPPLY | INPUT    | DIMENSIONS (MM) |
|----------------|----------------|----------------------------------|--------------------------------|----------------------------|----------|-----------------|
| DALI-2 MC1L PS | 86458507-1L-PS | application controller activated | 20mA (@120Vac), 10mA (@240Vac) | 50mA                       | 1 × 230V | 59 × 33 × 15    |
| DALI-2 MC2L PS | 86458507-2L-PS | application controller activated | 20mA (@120Vac), 10mA (@240Vac) | 50mA                       | 2 × 230V | 59 × 33 × 15    |

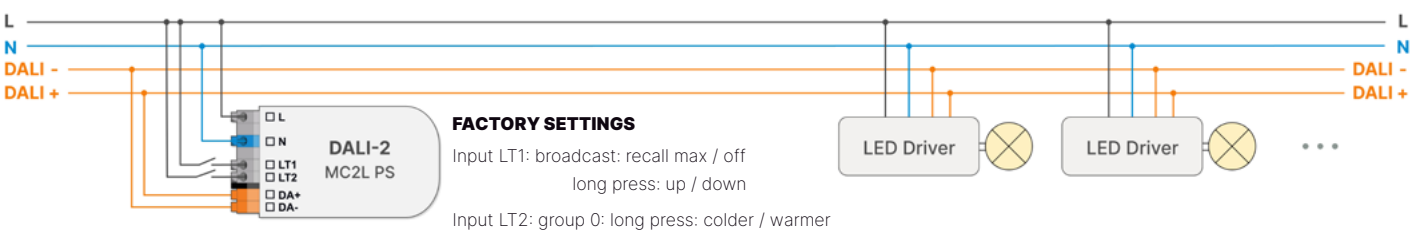

# DALI-2 MC4L POTI - pushbutton coupler

Interface with four switching inputs for mains voltage that are galvanically isolated from the DALI bus. Each input can be individually configured with target address, button behaviour and DALI commands. The light level for each input can be conveniently adjusted with the 4 potentiometers on the device. The LEDs indicate the active inputs.

Besides the standard functions, dimming, switching, scene recall, etc., predefined macros such as setting the colour temperature, dynamic scenes and sequences as well as user defined command lists are supported. In addition DALI DT8 TC and RGB(W) control is also supported.

In the delivery state the application controller is activated. With the DALI Cockpit PC software, the device can also be set to instance mode (no direct DALI control commands) for integration

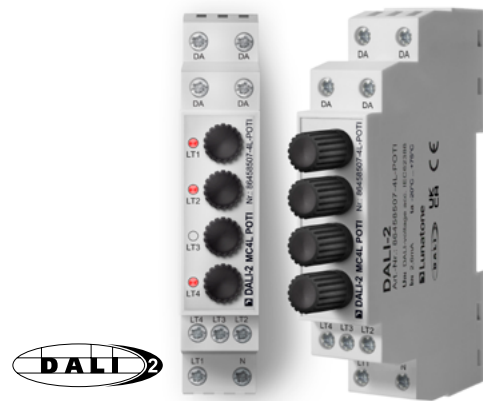

into higher-level building management systems from e.g. WAGO, Beckhoff.

The device is supplied via the DALI bus and is suitable for DIN rail mounting.

| NAME             | ARTICLE NUMBER   | FACTORY SETTING                  | NFC | SUPPLY        | DALI CURRENT CONSUMPTION | INPUT    | DIMENSIONS (MM) |
|------------------|------------------|----------------------------------|-----|---------------|--------------------------|----------|-----------------|
| DALI-2 MC4L POTI | 86458507-4L-POTI | application controller activated | no  | via DALI line | typ. 1,7mA               | 4 x 230V | 98 x 17,5 x 57  |

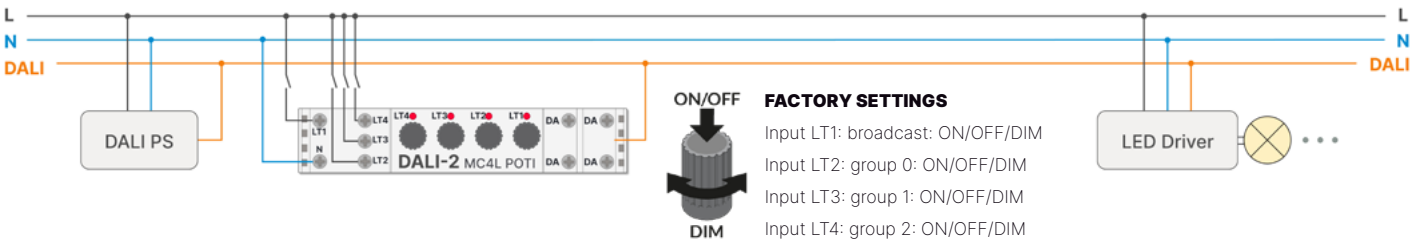

# DALI 100K - DALI interface for 100kΩ potentiometer

The DALI 100K enables the control of luminaires in a DALI system with a 100kΩ potentiometer. The analog input signal from the 100kΩ potentiometer is converted into a DALI light level (%), which is transmitted to the DALI bus. Whether the signal should be sent to the entire bus, to groups or to individual addresses can be set with the PC software DALI Cockpit. The analog signals from the potentiometer are either transmitted periodically (1 second - 60



minutes) or whenever the voltage changes (more than 2%). The device is supplied via the DALI bus and is designed to fit behind a potentiometer in a flush-type installation box.

| NAME      | ARTICLE NUMBER | STROMSUPPLY   | DALI CURRENT CONSUMPTION | OPERATING TEMPERATURE (TA) | DIMENSIONS (MM) |
|-----------|----------------|---------------|--------------------------|----------------------------|-----------------|
| DALI 100K | 86458506       | via DALI line | typ. 3mA                 | -20°C - +75°C              | 40 x 28 x 15    |

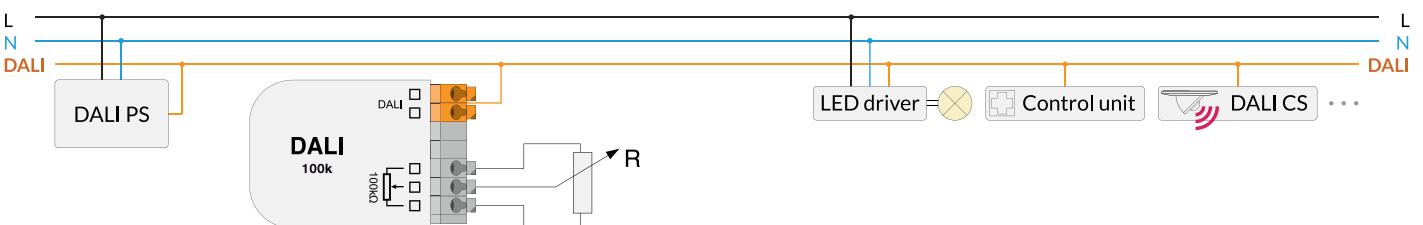



# EnOcean DALI-2 MC

Compact DALI-2 control module for connection of up to 4 EnOcean pushbuttons to the DALI system. Each of the 4 EnOcean inputs can be individually configured with target address, button behaviour and DALI commands. In addition to the standard functions of dimming, switching, scene recall, etc., predefined macros such as setting the colour temperature, dynamic scenes, and sequences, as well as user defined command lists are supported.

The device can be ordered with factory setting "application controller" or "instance mode". The factory setting can be changed with the PC software DALI Cockpit or Lunatone NFC app (module "-NFC"). When used as "application controller" the device sends direct control commands. In "Instance" mode only event messages are sent for integration in higher-level building



management systems with DALI connection, such as those from WAGO or Beckhoff.

The module with NFC supports the adjustment of selected settings via smartphone (NFC capable) with the Lunatone NFC Android app, in addition to the configuration via the DALI Cockpit. The device is designed to fit behind a switch in a flush-type installation box.

| NAME                          | ARTICLE NUMBER | FACTORY SETTING  | NFC | STROM-SUPPLY  | DALI CURRENT CONSUMPTION | INPUT TYPE                       | DIMENSIONS (MM) |
|-------------------------------|----------------|--|-----|---------------|--------------------------|----------------------------------|-----------------|
| EnOcean DALI-2 MC             | 86463327-app   | application controller activated   | no  | via DALI line | typ. 6mA                 | 4 x EnOcean - wireless (868 MHz) | 59 x 33 x 15    |
| EnOcean DALI-2 MC Integration | 86463327-int   | instance mode activated  | no  | via DALI line | typ. 6mA                 | 4 x EnOcean - wireless (868 MHz) | 59 x 33 x 15    |
| EnOcean DALI-2 MC NFC         | 86463327-NFC   | application controller activated, Android app DALI NFC for configuration | yes | via DALI line | typ. 6mA                 | 4 x EnOcean - wireless (868 MHz) | 59 x 33 x 15    |

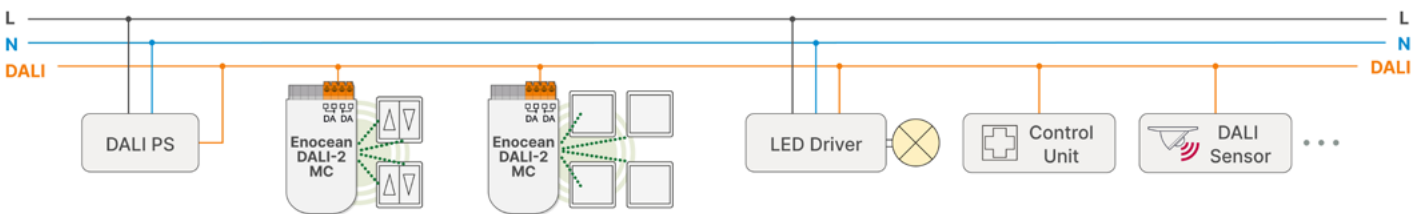

# DALI GC(-A) - controlling two DALI groups

DALI GC / GC-A is a control unit to address 2 DALI groups. With this compact module conventional light switches or pushbuttons can be used to send dimming and switching commands to 2 DALI groups. Using the dial on the back of the device the DALI groups can be selected. Configuration with the PC software DALI Cockpit is not necessary. The device is designed to fit behind a light switch in a flush-type installation box.

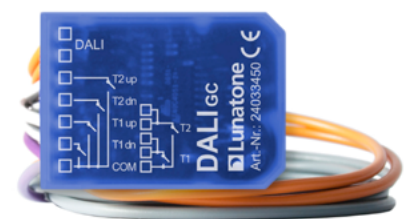

| NAME      | ARTICLE NUMBER | STROMSUPPLY   | DALI CURRENT CONSUMPTION | DIMENSIONS (MM) |
|-----------|----------------|---------------|--------------------------|-----------------|
| DALI GC   | 24033450       | via DALI line | typ. 6mA                 | 41x30x11        |
| DALI GC-A | 24138907       | via DALI line | typ. 6mA                 | 41x30x11        |

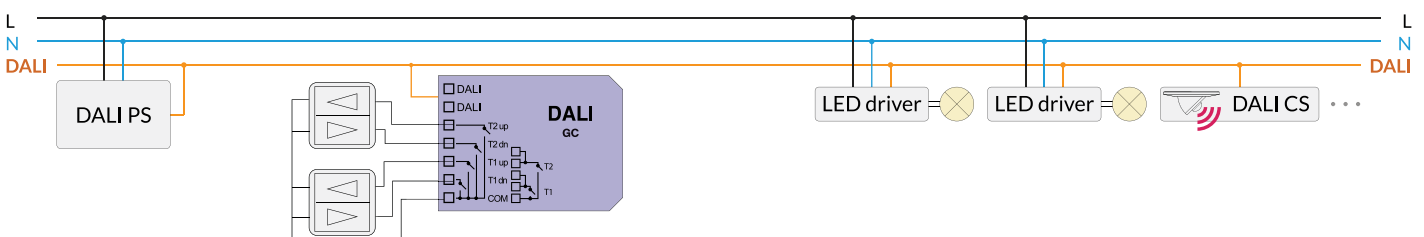



# DALI SC(-A) - controlling four DALI scenes

DALI SC / SC-A is a control unit to recall DALI scenes. A different light scene can be assigned to each of the 4 independent switch inputs. The dial on the back of the device can be used to define which of the 16 scenes will be recalled when the buttons are pressed. Configuration with the PC software DALI Cockpit is not necessary. The device is designed to fit behind a light switch in a flush-type installation box.

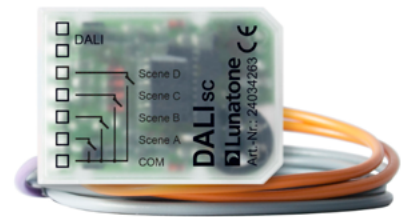

| NAME      | ARTICLE NUMBER | STROMSUPPLY   | DALI CURRENT CONSUMPTION | DIMENSIONS (MM) |
|-----------|----------------|---------------|--------------------------|-----------------|
| DALI SC   | 24034263       | via DALI line | typ. 6mA                 | 41×30×11        |
| DALI SC-A | 24138906       | via DALI line | typ. 6mA                 | 41×30×11        |

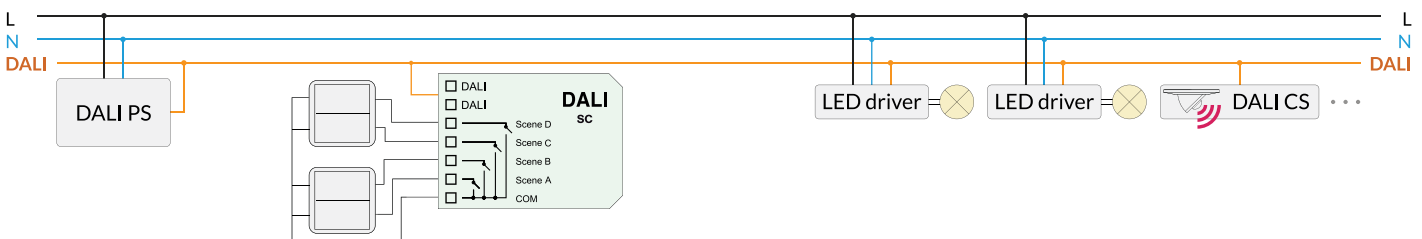

# DALI LR PS 20mA - automatic power reduction / night-time brightness reduction

Compact control module for automatic power reduction or night-time brightness reduction. Two operating modes are supported: operating mode B1 for power reduction through mains phase or control phase, operating mode B2 for power reduction based on virtual midnight calculation.

All necessary settings can be made using the rotary and slide switches on the device. The device has an integrated bus power supply (20mA) for up to 7 standard DALI loads, an extension to max. 64 loads is possible with a DALI Expander. The DALI LR PS20 is suitable for installation in flush-type installation boxes or integration in protection class II devices.



| NAME         | ARTICLE NUMBER | SUPPLY INPUT                          | INTEGRATED DALI POWER SUPPLY | OPERATING TEMPERATURE (TA) | DIMENSIONS (MM) |
|--------------|----------------|---------------------------------------|------------------------------|----------------------------|-----------------|
| DALI LR PS20 | 89453880       | mains voltage<br>220-240VAC / 50-60Hz | 20mA                         | -20°C ... +55°C            | 59 × 33 × 15    |

### Operating mode B1:

Power reduction through the mains control phase, the DALI LR is supplied via a separately switched phase.

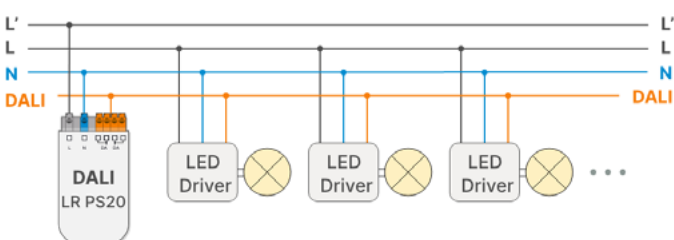

### Operating mode B2:

The DALI LR reduces the power during the operating time. The time span can be adjusted, it is always symmetrical to the user-defined virtual midnight.

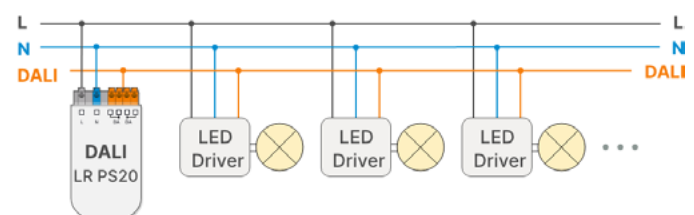

# DALI-2 Sequencer - recalling command sequences

DALI-2 control module to automatically recall pre-programmed DALI command sequences. A sequence consists of a series of max. 49 DALI commands, for example a set of colour and light level changes. 4 different sequences can be programmed with the PC software DALI Cockpit. Different delays can be configured for user defined sequences, with times ranging from 0 seconds to 3 hours. Furthermore, it is possible to define whether sequences are looped or run only once. Sequences can be recalled or stopped via scene commands or via the four switching inputs. It is possible to install several DALI-2 Sequencers on one DALI line. Different versions are available, suitable for DIN rail mounting or for installation in flush-type installation boxes.

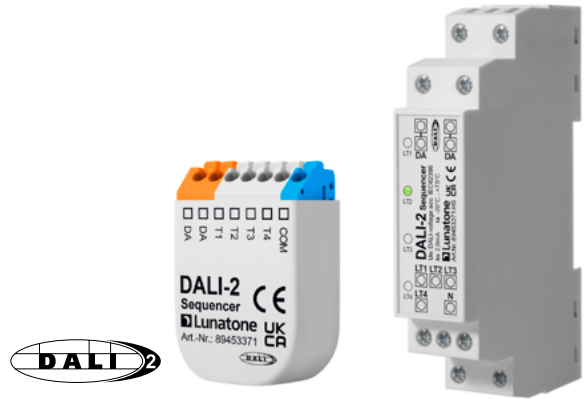

| NAME                      | ARTICEL NUMBER | CURRENT CONSUMPTION DALI | TIMER                | MODEL                             | DIMENSIONS (MM) |
|---------------------------|----------------|--------------------------|----------------------|-----------------------------------|-----------------|
| DALI-2 Sequencer          | 89453371       | typ. 1,7 mA              | quarz based(~20ppm)  | for flush-type installation boxes | 40 × 28 × 15    |
| DALI-2 Sequencer DIN rail | 89453371-HS    | typ. 1,7 mA              | quarz based (~20ppm) | for DIN rail                      | 98 × 17,5 × 57  |

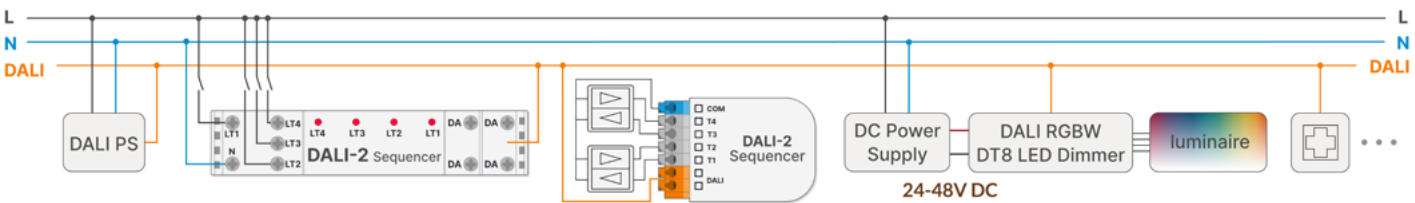

**FACTORY SETTINGS**

application controller active, effective range: broadcast

4 sequences can be recalled via the inputs:

T1,T2,T3,T4 (model for flush-type installation boxes)

LT1,LT2,LT3,LT4 (model for DIN rail)

sequence mode: M3 dynamic Scene: recall of scenes 0-15

Delay between scenes & fade time:

T1/LT1: 1sec

T3/LT3: 4sec

T2/LT2: 2sec

T4/LT4: 8sec

The sequence runs from scene 0 to scene 15 with 1/2/4/8sec delay and 1/2/4/8sec fade time per scene and is then repeated.

**Settings option: "User defined Macros"**

Via the configuration panel "User defined Macros" it is possible to define a sequence of DALI commands and its effective range.

Up to 4 sequences (sequence A - sequence D) can be saved in the DALI-2 sequencer.

To create or load a custom macro: select "Macro M5: User Defined Command List" from the Command menu.

A custom sequence can consist of up to 49 DALI commands.

effective range

DALI command

Delay times in ms, delays are adjustable between 0 seconds to max. 3 hours.

Click "Add..." to add a new entry to the command list. The new entry can contain a DALI command, the effective range for the command and a delay to the following command.

| Type | Addr  | Command                       | Data | Delay |
|------|-------|-------------------------------|------|-------|
| DALI | G0    | GOTO SCENE 0                  | 224  | 1000  |
| DALI | Bcast | RECALL MAX LEVEL              |      | 10000 |
| DALI | G1    | DIRECT ARC POWER 233 (56.36%) | 233  | 10000 |
| DALI | A0    | DIRECT ARC POWER 203 (24.85%) | 203  | 50000 |
| DALI | Bcast | RECALL MIN LEVEL              |      | 10000 |

# DALI CDC - time based colour temperature control

DALI CDC is a control unit that automatically adjusts the colour temperature and light level during the day to simulate daylight, so-called Human Centric Lighting. The device is used together with DALI DT8 TC (tunable white) luminaries. The sequence can be activated and deactivated using scene recalls. Smooth transitions are ensured by sending commands periodically. The sequence can be adjusted with the PC software DALI Cockpit.

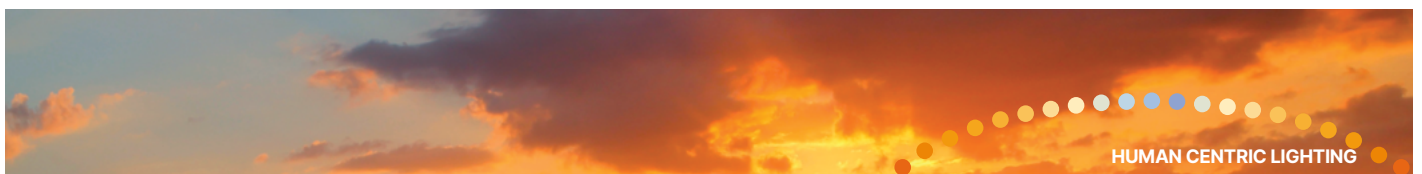

| NAME              | ARTICEL NUMBER | CURRENT CONSUMPTION DALI | TIMER                | MODEL                             | DIMENSIONS (MM) |
|-------------------|----------------|--------------------------|----------------------|-----------------------------------|-----------------|
| DALI CDC          | 89453853       | typ. 5mA                 | quarz based (~20ppm) | for flush-type installation boxes | 59 × 33 × 15    |
| DALI CDC DIN rail | 89453853-HS    | typ. 5mA                 | quarz based (~20ppm) | for DIN rail                      | 98 × 17,5 × 57  |

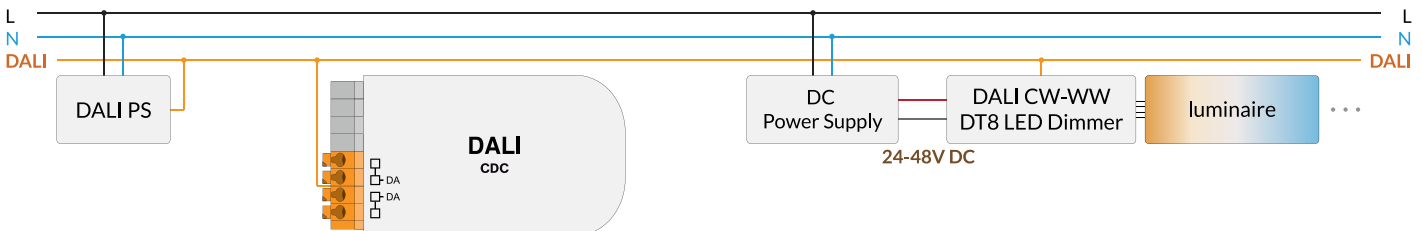

### FACTORY SETTINGS

From 18:00 - 06:00: warm light, from 06:00 - 12:00 the light gradually gets colder, at 12:00 o'clock the colour temperature is 5800K, after that the light will gradually warm up again until 18.00 o'clock. When delivered, the brightness is not controlled or changed (DAP = "MASK"). If required, time-based light levels can be set.

Light levels as well as temperature values (in Kelvin) can be changed with the PC software DALI Cockpit.

Parameters can also be set with the DALI Daylight App. page 29A

| time  | colour temperature | brightness |
|-------|--------------------|------------|
| 24:00 | 2700K              | MASK       |
| 01:00 | 2700K              | MASK       |
| 02:00 | 2700K              | MASK       |
| 03:00 | 2700K              | MASK       |
| 04:00 | 2700K              | MASK       |
| 05:00 | 2700K              | MASK       |
| 06:00 | 2700K              | MASK       |
| 07:00 | 3412K              | MASK       |
| 08:00 | 4101K              | MASK       |
| 09:00 | 4767K              | MASK       |
| 10:00 | 5318K              | MASK       |
| 11:00 | 5685K              | MASK       |
| 12:00 | 5800K              | MASK       |
| 13:00 | 5685K              | MASK       |
| 14:00 | 5318K              | MASK       |
| 15:00 | 4767K              | MASK       |
| 16:00 | 4101K              | MASK       |
| 17:00 | 3412K              | MASK       |
| 18:00 | 2700K              | MASK       |
| 19:00 | 2700K              | MASK       |
| 20:00 | 2700K              | MASK       |
| 21:00 | 2700K              | MASK       |
| 22:00 | 2700K              | MASK       |
| 23:00 | 2700K              | MASK       |

# DALI-2 RTC+ Timer

The timer module DALI-2 RTC+ enables the configuration and query of date and time as well as time based control of the DALI system – scheduler function.

Up to 32 entries can be defined, each consisting of weekday, days of the month, months, time stamp and DALI commands. Timestamps can be selected not only in absolute terms but also in relation to sunrise and sunset – Astroclock function. The scheduler entries can be activated/deactivated via scene commands. An automatic switchover to daylight saving time can be set.



The device is suitable for installation in flush-type installation boxes or integration in protection class II devices.

| NAME              | ARTICEL NUMBER | CURRENT CONSUMPTION DALI | TIMER                | MODEL                             | DIMENSIONS (MM) |
|-------------------|----------------|--------------------------|----------------------|-----------------------------------|-----------------|
| DALI-2 RTC+ Timer | 86457142       | typ. 5mA                 | quarz based (~20ppm) | for flush-type installation boxes | 40 × 28 × 15    |

date, time or an external control can be selected as triggers

effective range of the timer module: entire DALI bus (broadcast), group(s) or individual address(es)

enter the DALI control command or sequence that should be executed on the selected date

# DALI NFC App - configuration of basic settings

The DALI NFC App provides an easy and straightforward way to set up and configure DALI devices with a smartphone using Near Field Communication (NFC). It enables reading of device information and configuration of basic settings, including effective range (broadcast, groups or individual addresses).

An important advantage of NFC is that devices can be configured before installation, in an unpowered state.

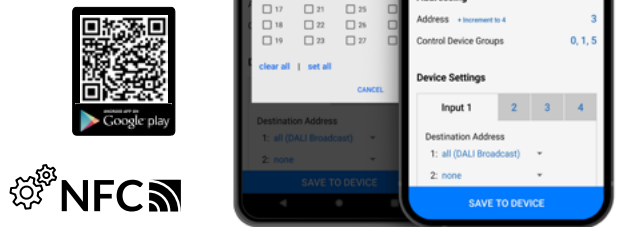

### Application example:

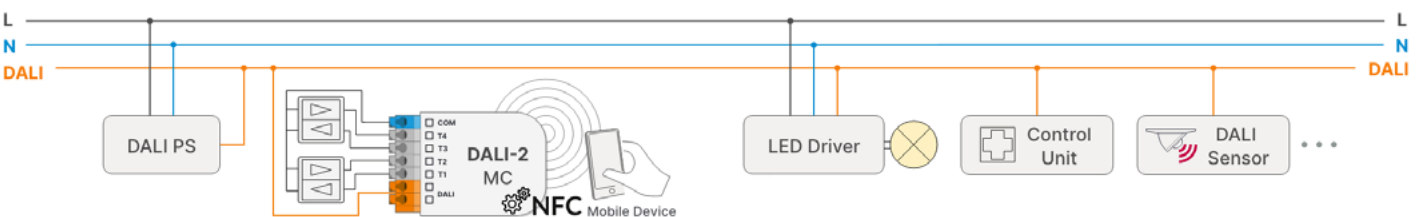

# DALI Daylight Interface

DALI Daylight Interface incl. App for iOS and Android allows basic adjustment of the following devices via Bluetooth:

- DALI CDC: changing circadian curve settings (start, peak, end)
- DALI RTC: definition of 2 switching intervals per weekday
- DALI CS: setting light level and hold time
- DALI LS: switching between manual and automatic light level control, specifying the reference light level



## DALI Daylight

Here you can download the app for your smartphone!



| NAME                    | ARTICLE NUMBER | INPUT SUPPLY CURRENT | TYP. DALI CURRENT CONSUMPTION | DIMENSIONS (MM) |
|-------------------------|----------------|----------------------|-------------------------------|-----------------|
| DALI Daylight Interface | 89453863       | via DALI line        | typ. 4mA                      | 59 × 33 × 15    |

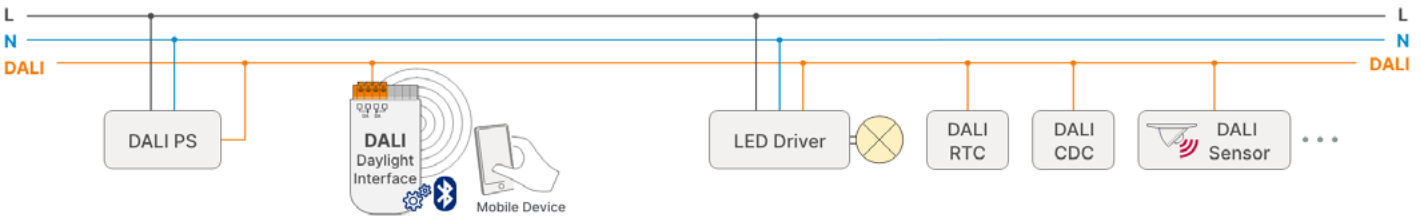

# DALI-2 Audio Interface

DALI-2 device for playing internet radio stations. Speakers or intercom systems can be easily connected via a corresponding connector. The control of radio stations and volume works via DALI. Up to 16 internet radio stations can be accessed via scenes. The WLAN interface is used for integration into the local network and to access the internet radio stations.

Configurations can be made with the Lunatone PC software DALI Cockpit.

The device is suitable for remote ceiling installation or integration in luminaires.



| NAME                   | ARTICLE NUMBER | INTERFACE  | INPUT SUPPLY CURRENT                         | OPERATING TEMPERATURE (TA) | DIMENSIONS (MM) |
|------------------------|----------------|------------|--|----------------------------|-----------------|
| DALI-2 Audio Interface | 89943721       | DALI, WLAN | mains voltage 31mA (@110Vac), 21mA (@240Vac) | -20°C ... +60°C            | 159× 41 × 22    |

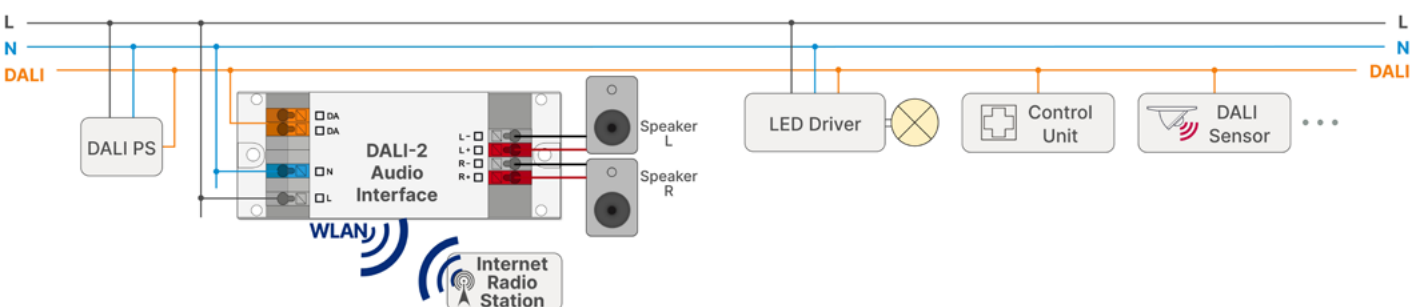

# DALI-2 CS - sensor module

Compact sensor module with motion detection (PIR) and light intensity measurement for DALI and DALI-2 systems. The module can either be used to directly control the DALI system (application controller) or simply to gather measurements for a building management system (instance mode).

The DALI-2 CS can be configured with the PC software DALI Cockpit to send various DALI commands upon motion detection (on/off, max, min, scene, ...) to either the entire DALI system, groups, or individual addresses.

The module contains a light sensor and can automatically adjust room lighting (constant light control). 4 operating modes are supported: motion triggered; motion triggered with constant light control; constant light control; light control via 4 thresholds. All measured values can be read out via the DALI line. In addition, alternative behaviour and parameters can be set, for example to change between different destination addresses or light values. Multiple sensors within one group will synchronise automatically. The device is powered directly by the DALI bus.

DALI-2 CS is available in three different housings: for direct mounting on cavity walls or installation boxes (standard), for suspended ceilings (with spring), or for surface mounting (with backbox). Available housing colours are pure white RAL 9010, traffic white RAL 9016 (-W16) or black (-B).

Factory setting: motion detection and 10min hold time before the off command.

Version DALI-2 CS “-THP” offers an integrated temperature,



relative humidity and air pressure sensor and version “-THP-AQ” adds air quality measurement to the above.

| NAME                         | ARTICEL NUMBER BASE | BRIEF DESCRIPTION  | INTER-FACE | SUPPLY        | DALI CURRENT CONSUMPTION | (TA) OPERATING TEMPERATURE                                       |
|------------------------------|---------------------|--|------------|---------------|--------------------------|--|
| DALI-2 CS                    | 86458670-__         | DALI-2 sensor for motion and light, <b>application controller and instance mode</b>  | DALI       | via DALI line | typ. 3,5mA               |  |
| DALI-2 CS Integration        | 86458670-INT-__     | DALI-2 sensor for motion and light, <b>instance mode</b> for Integration in systems with central control units   | DALI       | via DALI line | typ. 3,5mA               | -20°C ... +60°C  |
| DALI-2 CS Integration THP    | 86457786-INT-__     | DALI-2 sensor for motion, light, temperature, relative humidity and air pressure, <b>instance mode</b> for Integration in systems with central control units             | DALI       | via DALI line | typ. 3,5mA               | exept sensor High Density Long Distance Art.Nr.: 86458670_-15-_- |
| DALI-2 CS Integration THP-AQ | 86457786-INT-AQ-__  | sensor for motion, light, temperature, relative humidity, air pressure and <b>air quality, eCO2; instance mode</b> for Integration in systems with central control units | DALI       | via DALI line | typ. 3,5mA               | -20°C ... +55°C  |

## Installation example DALI-2 CS Integration:

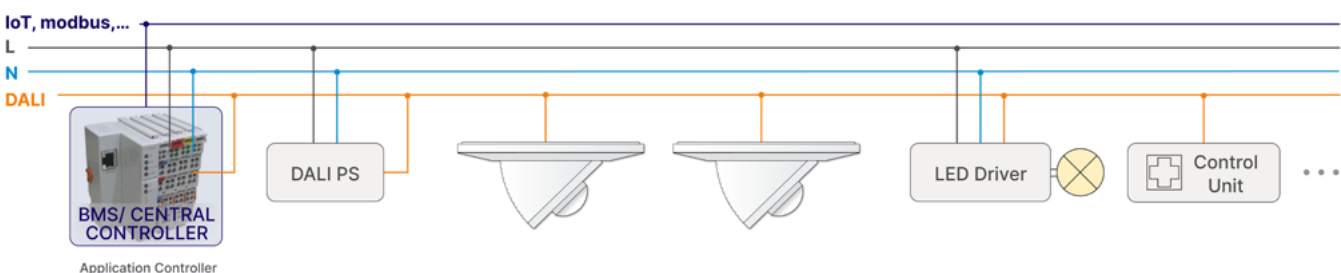



Part numbering system DALI-2 CS: LIGHT AND MOTION SENSOR (PIR)

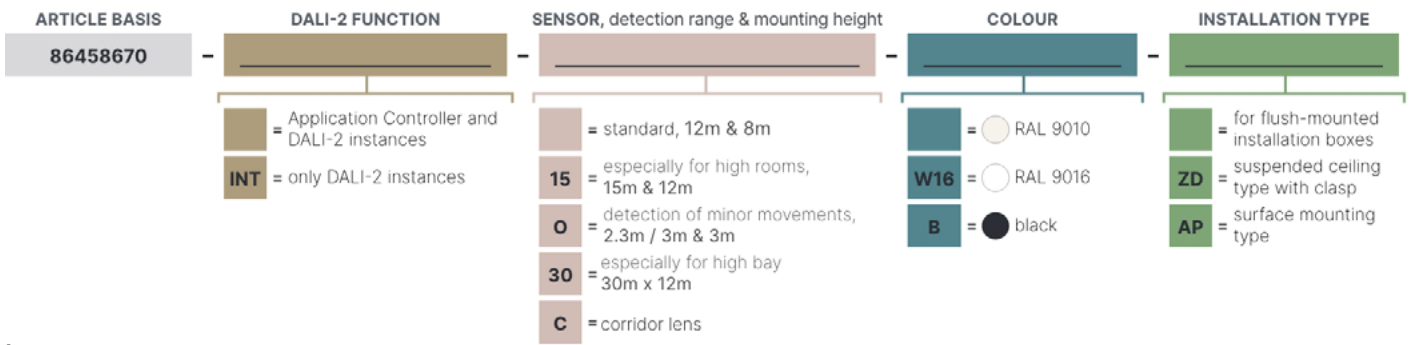

Lens types:

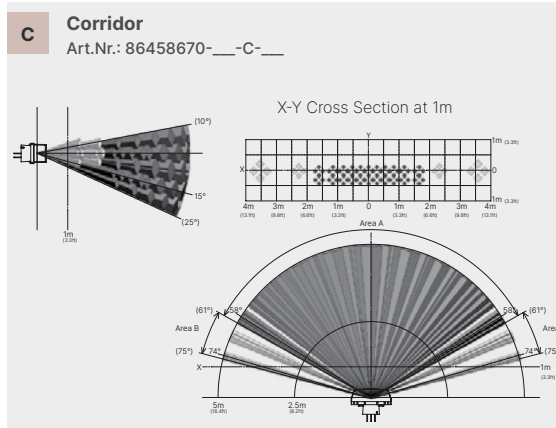
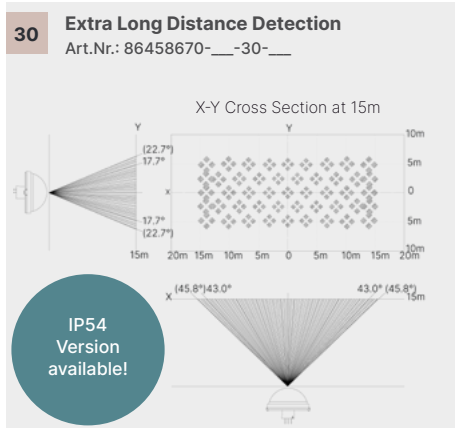
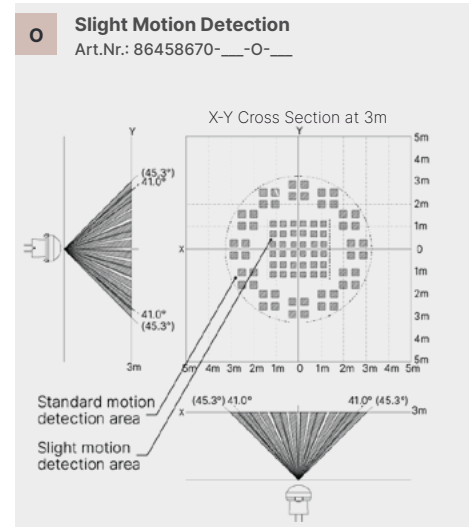
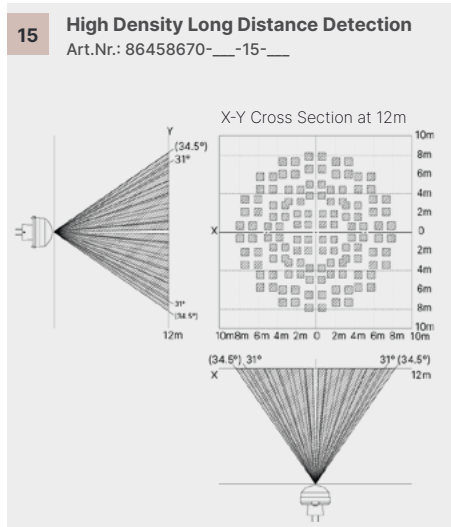
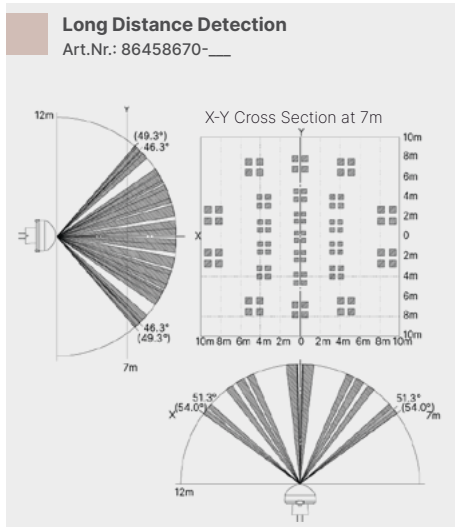

Installation types:

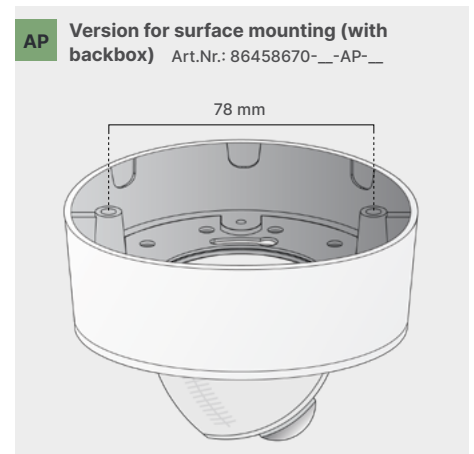
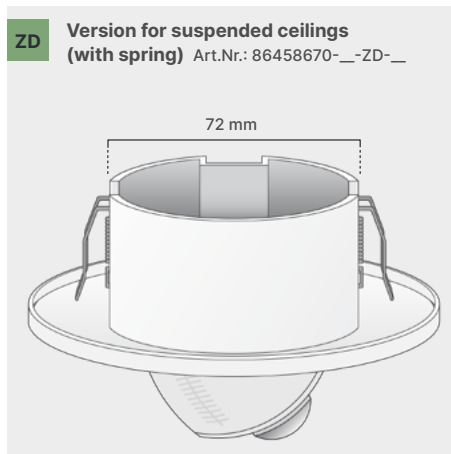
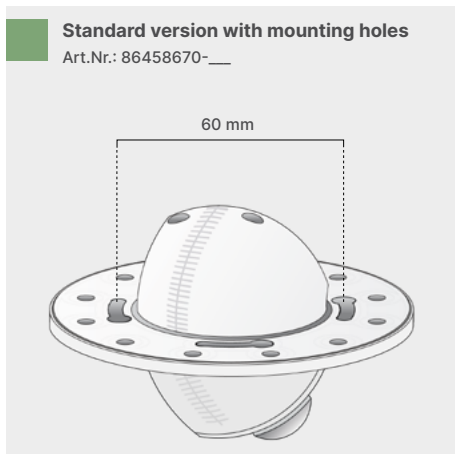



Part numbering system **DALI-2 CS THP: LIGHT AND MOTION SENSOR (PIR) + TEMPERATURE, HUMIDITY, AIR PRESSURE, (AIR QUALITY WITH -AQ)**

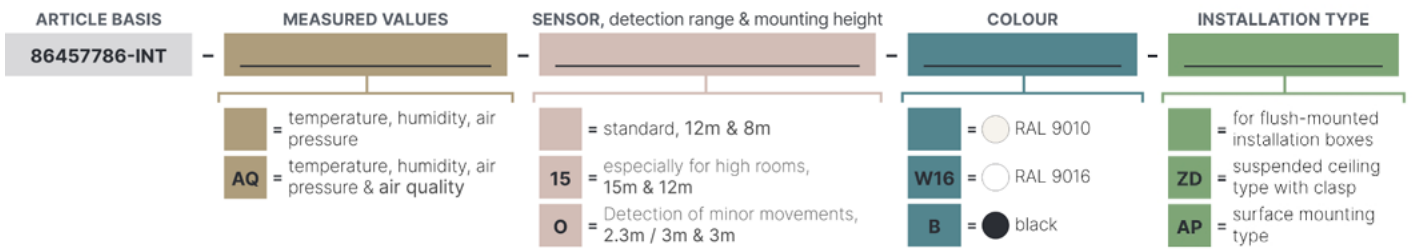

Lens types:

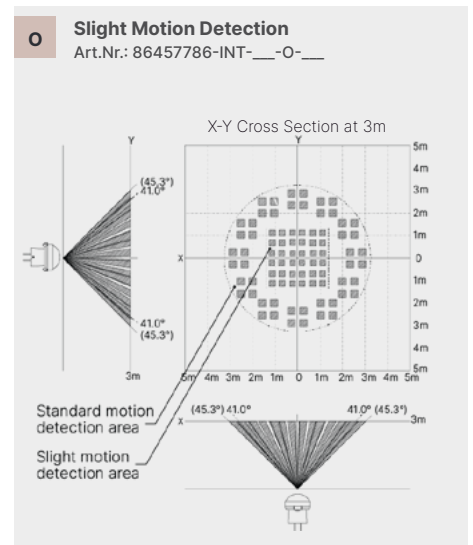
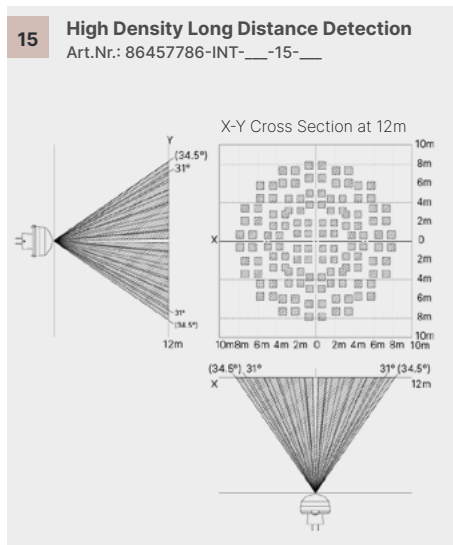
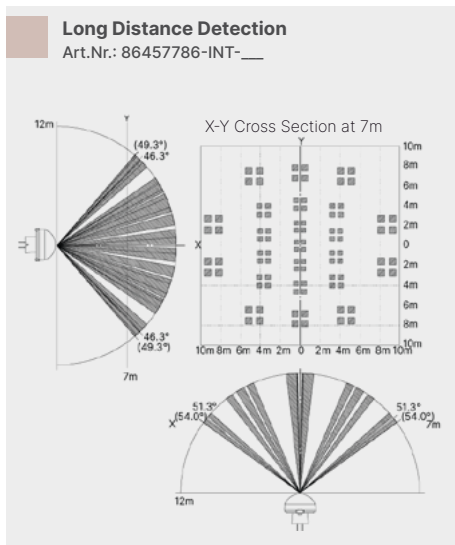

Installation types:

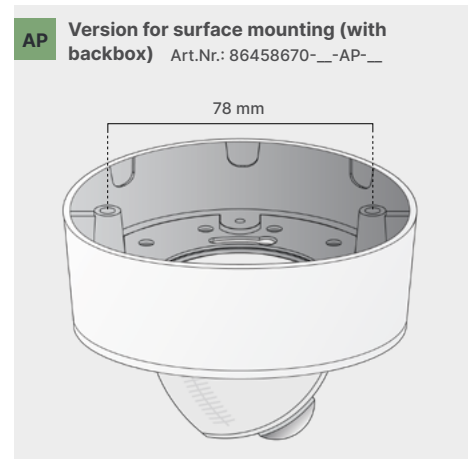
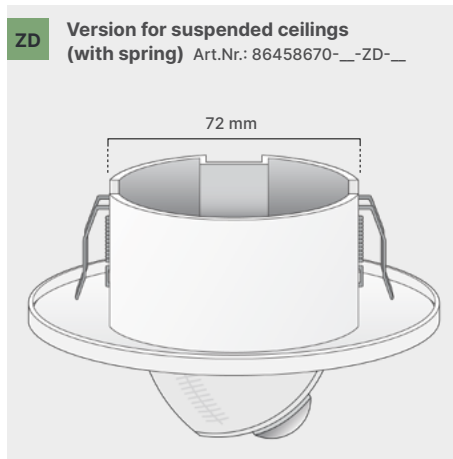
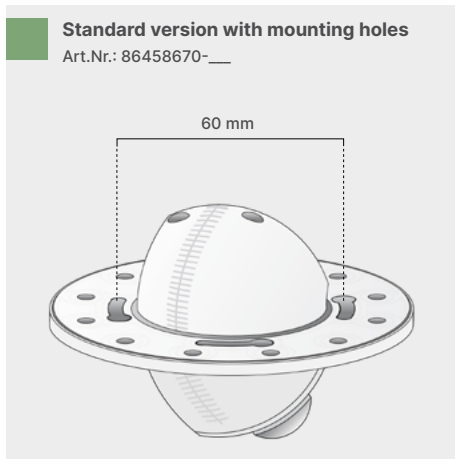



Device Info

|              |           |                |                              |      |    |
|--------------|-----------|----------------|------------------------------|------|----|
| Name         | DALI-2 CS | Article Number | N/A                          | GTIN |    |
| Manufacturer | Lunatone  | Serial Number  | 1                            | FW   | ?? |
| Device Type  | -         | Type           | Control Device               |      |    |
| DALI Ver     | unknown   | Short Address  | (A0 <sup>2</sup> ) DALI-2 CS |      |    |

General Instances Wirkbereich Motion Control

Behavior on movement

Current Light Level  Lux

Sequence

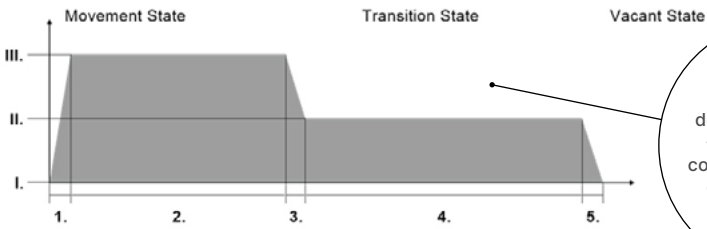

with retriggering

Movement state

1. On Command Light Level (DAP) Light Level: 100 %

Fade time  [7] 5.6 sec

2. Hold Time

30 min 0 sec

Transition state

3. Mid Level Command RECALL MIN LEVEL

4. Second Level Hold Time 10 min 0 sec

Vacant State

5. Off Command OFF

Switch-on threshold

Cmd X only sent if light value > threshold value (i.e. day)

Threshold: 600 Lux

Cmd X only sent if light value < threshold value (i.e. night)

Hysteresis: 50 Lux

Bright Out: Retrigger by motion only if Light Level < Bright-Out-Threshold

Bright-Out-Threshold: 500 Lux

Cmd X is independent of the light sensor

Behavior at external commands on the sensor destinations

|         |                     |
|---------|---------------------|
| ON      | Movement simulation |
| OFF     | End of sequence     |
| Dimming | no influence        |

Variable Operating Behavior

Activation

Scene Command On Destination Address

Scene Command On own DALI Address

Scene 0 3 - Alternative Destinations G5

Scene 1 4 - Alternative On Command(1) Light Level DAP 80 %

Scene 0 1 - no action

Scene 0 1 - no action

this graph shows the different stages of the sensors lighting control - the points below refer to this graph

shows currently measured light value as a reference

settings for the motion detection sequence -> with or without constant light control, depending on the operating mode

command that is executed when motion is detected -> section 1 in the graph  
The following commands can be selected as ON-commands: light intensity (%), max, min, scene 0-15, last active light level

Hold Time: How long should the 1st light level be active for -> section 2 in the graph

command executed after the 1st  
Hold Time: -> section 3 in the graph  
the following commands can be selected for the Mid Level Command: no action, light intensity (%), max, min, scene 0-15, last active light level

switch-on and switch-off threshold: it can be defined above or below which threshold value the motion and light control is active

2nd level Hold Time: How long should the second light level be active for -> section 4 in the graph

command executed after the 2nd Hold Time: -> section 5 in the graph  
the following commands can be used as OFF commands: light intensity 0%, off, scene 0-15

definition of the device behaviour, when an external on / off / dimming command is sent to the sensors effective range - depending on the operating mode

the behaviour of the sensor can be changed by recalling a scene

# DALI-2 CS Integration THP LE

- sensor for installation in luminaires
- for integration in systems with central control units
- measurement of motion, light, temperature, relative humidity, air pressure (and air quality -AQ)

Compact sensor module for DALI-2 systems with motion detection (PIR), light intensity, temperature, relative humidity, air pressure measurement and additional air quality sensor with version -AQ. The module gathers measurements for a building management system – (DALI-2 CS Master, WAGO, Beckhoff, etc.). The measured values can be queried or automatically trigger events when sensor value changes occur. This functionality is implemented via DALI-2 instances. The DALI-2 CS Integration can be configured accordingly in the PC software DALI Cockpit. The device is powered directly by the DALI bus.

Factory setting: On delivery the motion and light instance events are active. The device can be installed in combination with



DALI-2 CS without further configuration by assigning the DALI-2 CS as master.

| NAME                                  | ARTICEL NUMBER         | BRIEF DESCRIPTION  | INTERFACE | SUPPLY        | DALI CURRENT CONSUMPTION | (TA)OPERATING TEMPERATURE |
|---------------------------------------|------------------------|--|-----------|---------------|--------------------------|---------------------------|
| DALI-2 CS Integration THP LE          | 86457786-INT-LE        | motion, light, temperature, relative humidity, air pressure; <b>instance mode</b> for system integration; luminaire installation; black                            | DALI      | via DALI line | typ. 3,5mA               | -20°C ... +60°C           |
| DALI-2 CS Integration THP LE AQ       | 86457786-INT-AQ-LE     | motion, light, temperature, relative humidity, air pressure, <b>air quality, eCO2; instance mode</b> for system integration; luminaire installation; black         | DALI      | via DALI line | typ. 3,5mA               | -20°C ... +60°C           |
| DALI-2 CS Integration THP LE White    | 86457786-INT-LE-W16    | motion, light, temperature, relative humidity, air pressure; <b>instance mode</b> for system integration; luminaire installation; white RAL9016                    | DALI      | via DALI line | typ. 3,5mA               | -20°C ... +60°C           |
| DALI-2 CS Integration THP LE AQ White | 86457786-INT-AQ-LE-W16 | motion, light, temperature, relative humidity, air pressure, <b>air quality, eCO2; instance mode</b> for system integration; luminaire installation; white RAL9016 | DALI      | via DALI line | typ. 3,5mA               | -20°C ... +60°C           |

## Part numbering system DALI-2 CS Integration THP LE:

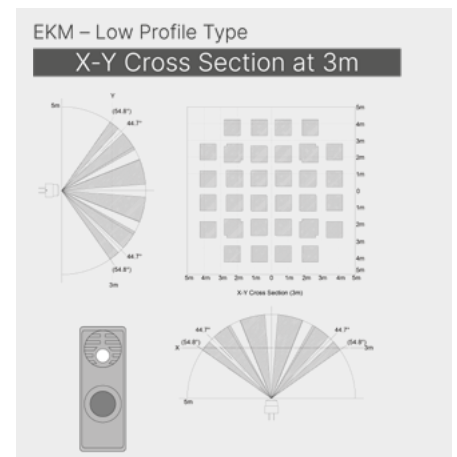
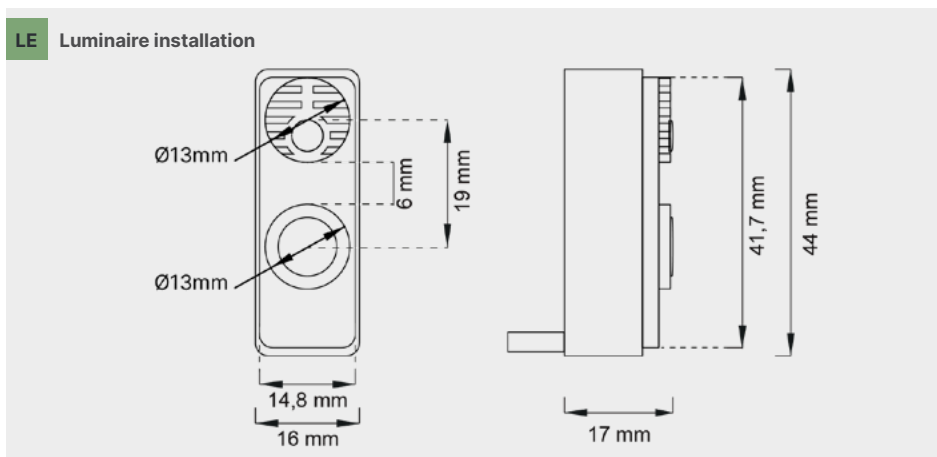
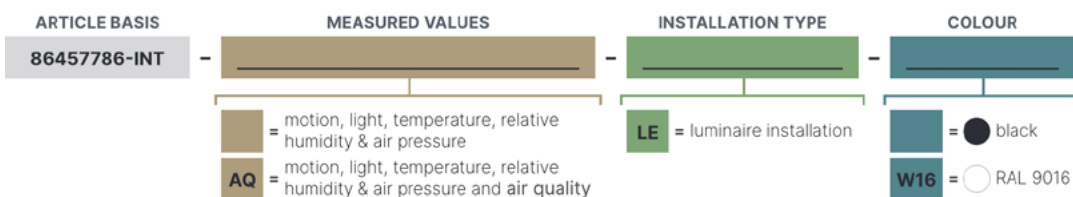

# DALI-2 CS Mini

Compact sensor module with integrated motion detection (PIR), light intensity measurement and light control unit.

In addition to the standard detection in the outer area, DALI-2 CS Mini has a more sensitive inner detection area for the detection of minor movements.

DALI-2 CS Mini can be configured with the PC software DALI Cockpit to send various DALI commands upon motion detection to either the entire DALI system, groups or individual addresses. The module also contains a light sensor to deactivate motion detection when there is sufficient lighting. Activating the integrated light control unit enables DALI constant light control in a simple manner. Several sensors can be used in a group, one sensor can be selected as master, while the others feed in their light and motion sensor values, the evaluation can be set to minimum, maximum or average value.

The device is powered directly by the DALI bus.

The module is available in two different versions: for indoor and outdoor use (IP65), as well as two different colours: black and white (RAL9016)

**Art.Nr.: 86457244-INT-\_\_ : Version for integration in systems with central control units:**

DALI-2 CS Mini Integration gathers measurements for a building



management system (DALI-2 CS Master, WAGO, Beckhoff, etc.). The measured values can be queried or automatically trigger events when sensor value changes occur. This functionality is implemented via DALI-2 instances. The DALI-2 CS Mini Integration can be configured accordingly in the PC software DALI Cockpit. The device is powered directly by the DALI bus.

| NAME                       | ARTICEL NUMBER BASE | BRIEF DESCRIPTION  | INTERFACE | SUPPLY        | DALI CURRENT CONSUMPTION | (TA)OPERATING TEMPERATURE |
|----------------------------|---------------------|--|-----------|---------------|--------------------------|---------------------------|
| DALI-2 CS Mini             | 86457244-__         | sensor module (motion/brightness), presence sensor 2.5m, constant light control; <b>application controller</b> activated     | DALI      | via DALI line | typ. 3,5mA               | -20°C ... +60°C           |
| DALI-2 CS Mini Integration | 86457244-INT-__     | sensor module (motion/brightness), presence sensor 2.5m, constant light control; <b>instance mode</b> for system integration | DALI      | via DALI line | typ. 3,5mA               | -20°C ... +60°C           |

### Part numbering system DALI-2 CS Mini:

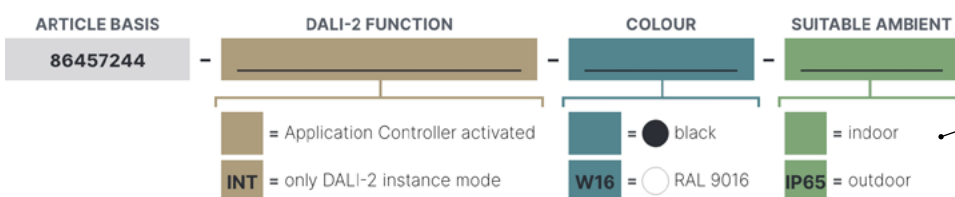

standard version for indoor use (IP20) or Art.Nr.: 86457244-\_\_-IP65 for outdoor use (IP65)

### Lens type: Slight Motion Detection

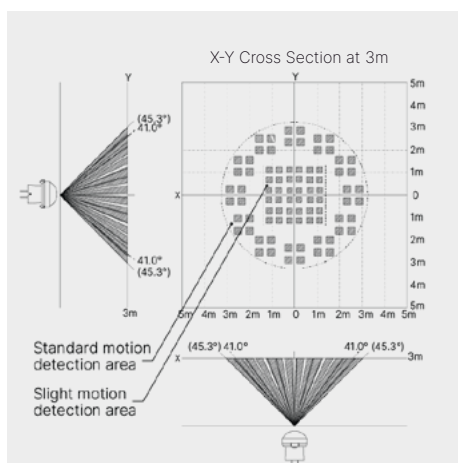

### Dimensions of sensor

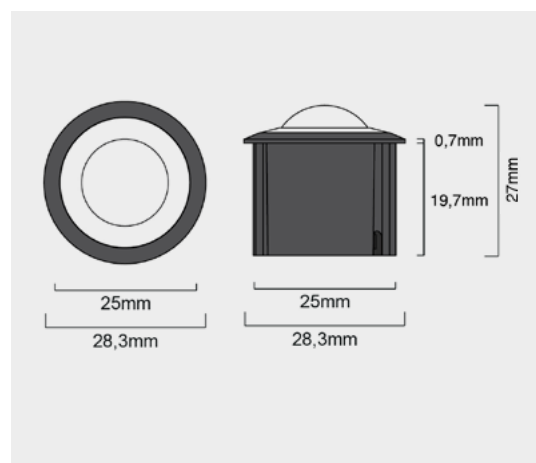

### Accessories

Cover to limit the detection area

| ARTICLE NUMBER   | COLOUR |
|------------------|--------|
| 86457244-Z01-B   | ●      |
| 86457244-Z01-W16 | ○      |

# DALI-2 CS Corridor

Compact sensor module with integrated motion detection (PIR), light intensity measurement and light control unit.

Due to the horizontal detection angle (150°), the sensor is particularly suitable for wall mounting, e.g. in corridors.

DALI-2 CS Corridor can be configured with the PC software DALI Cockpit to send various DALI commands upon motion detection to either the entire DALI system, groups or individual addresses.

The module also contains a light sensor to deactivate motion detection when there is sufficient lighting. Activating the integrated light control unit enables DALI constant light control in a simple manner. Several sensors can be used in a group, one sensor can be selected as master, while the others feed in their light and motion sensor values, the evaluation can be set to minimum, maximum or average value.

The device is powered directly by the DALI bus.

The module is available in two different versions: for indoor and outdoor use (IP65)

## Art.Nr.: 88793325-INT- : Version for integration in systems with central control units:

DALI-2 CS Corridor Integration gathers measurements for a



building management system (DALI-2 CS Master, WAGO, Beckhoff, etc.). The measured values can be queried or automatically trigger events when sensor value changes occur. This functionality is implemented via DALI-2 instances. The DALI-2 CS Corridor Integration can be configured accordingly in the PC software DALI Cockpit. The device is powered directly by the DALI bus.

| NAME                                | ARTICLE NUMBER    | BRIEF DESCRIPTION  | INTERFACE | SUPPLY        | DALI CURRENT CONSUMPTION | (TA) OPERATING TEMPERATURE | OPERATION AREA     |
|-------------------------------------|-------------------|--|-----------|---------------|--------------------------|----------------------------|--------------------|
| DALI-2 CS Corridor                  | 88793325          | horizontal detection angle for motion, brightness; constant light control; application controller activated                                | DALI      | via DALI line | typ. 3,5mA               | -20°C ... +60°C            | indoor use (IP20)  |
| DALI-2 CS Corridor IP65             | 88793325-IP65     | horizontal detection angle for motion, brightness; constant light control; application controller activated                                | DALI      | via DALI line | typ. 3,5mA               | -20°C ... +60°C            | outdoor use (IP65) |
| DALI-2 CS Corridor Integration      | 88793325-INT      | horizontal detection angle for motion, brightness; constant light control; <b>instance mode</b> for Integration with central control units | DALI      | via DALI line | typ. 3,5mA               | -20°C ... +60°C            | indoor use (IP20)  |
| DALI-2 CS Corridor Integration IP65 | 88793325-INT-IP65 | horizontal detection angle for motion, brightness; constant light control; <b>instance mode</b> for Integration with central control units | DALI      | via DALI line | typ. 3,5mA               | -20°C ... +60°C            | outdoor use (IP65) |

### horizontal detection angle

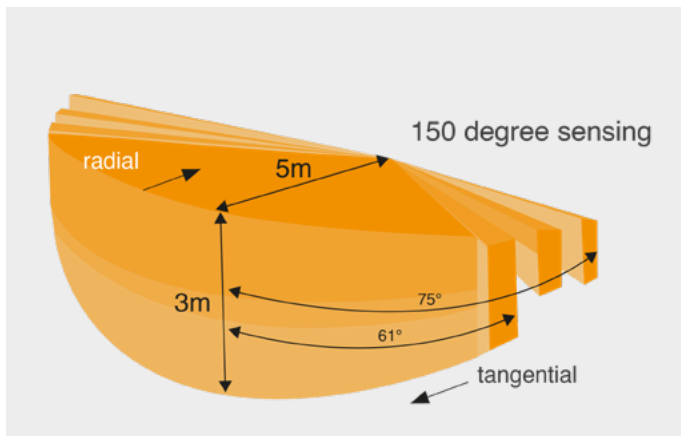

### Dimensions of sensor

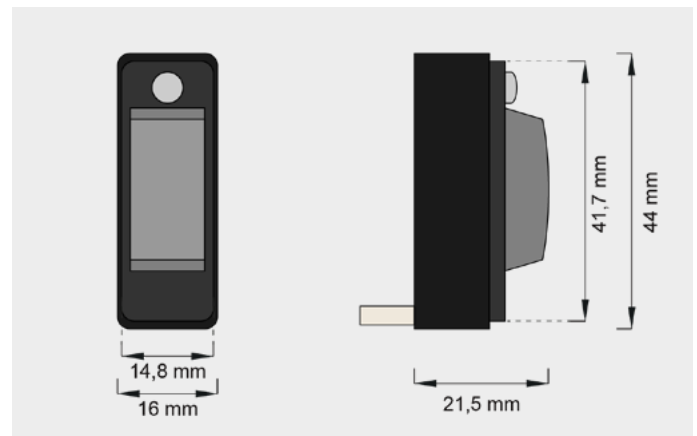



# DALI CS with 20mA DALI bus power supply

Compact DALI motion and light sensor with integrated bus power supply. The module consists of a ceiling insert housing and a sensor unit. The module can be used as a control unit for a DALI system or integrated in a building management system as simple sensor unit. The module is suitable for various applications such as offices, class rooms, corridors or halls. Following settings can be configured: target address, DALI control commands, constant light control and hold time. Several sensors can be used in a group, the sensors are synchronised automatically.

Images from left to right: Art.Nr.: 89453862, Art.Nr.: 89453862-15, Art.Nr.: 89453862-O

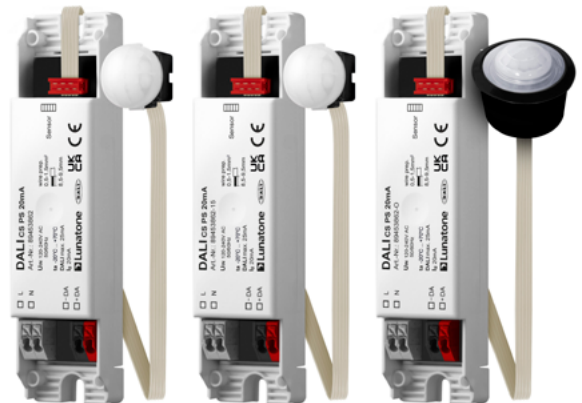

| NAME                 | ARTICLE NUMBER | BRIEF DESCRIPTION  | DETECTION RANGE | MOUNTING HEIGHT | DALI CURRENT CONSUMPTION | INTEGRATED DALI POWER SUPPLY |
|----------------------|----------------|--|-----------------|-----------------|--------------------------|------------------------------|
| DALI CS PS 20mA 12m  | 89453862       | motion, brightness sensor 12m, constant light control,                     | 12m &           | max. 8m         | typ. 3,5mA               | 20mA                         |
| DALI CS PS 20mA 15m  | 89453862-15    | motion, brightness sensor 15m / max 12m mounting height                    | 15m & 12m       | max. 12m        | typ. 3,5mA               | 20mA                         |
| DALI CS PS 20mA 2,5m | 89453862-O     | motion, brightness, presence sensor 2.5m (office), constant light control, | 2.3m / 3m       | max. 3m         | typ. 3,5mA               | 20mA                         |

# DALI SI, SI-1L

Sensor Interface to connect e.g. conventional motion sensors, contact switches or photoelectric sensors to a DALI system. Configuration options are similar to the DALI CS: effective range, target address, DALI commands for on/off and hold times, light levels etc. Multiple sensors within one group synchronise automatically. Two different versions are available, one with switching input for potential free contacts (DALI SI), the other with switching input for mains voltage (DALI SI1L). The device is designed to fit behind a light switch in a flush-type installation box.



| NAME       | ARTICLE NUMBER | INPUT SUPPLY CURRENT | TYP. DALI CURRENT CONSUMPTION | CONTROL INPUT                                | DIMENSIONS (MM) |
|------------|----------------|----------------------|-------------------------------|--|-----------------|
| DALI SI    | 89453850       | via DALI line        | 2,9mA                         | 1 switching input for potential free contact | 40 × 28 × 15    |
| DALI SI-1L | 89453850-1L    | via DALI line        | 2,9mA                         | 1 switching input for mains voltage          | 59 × 33 × 15    |

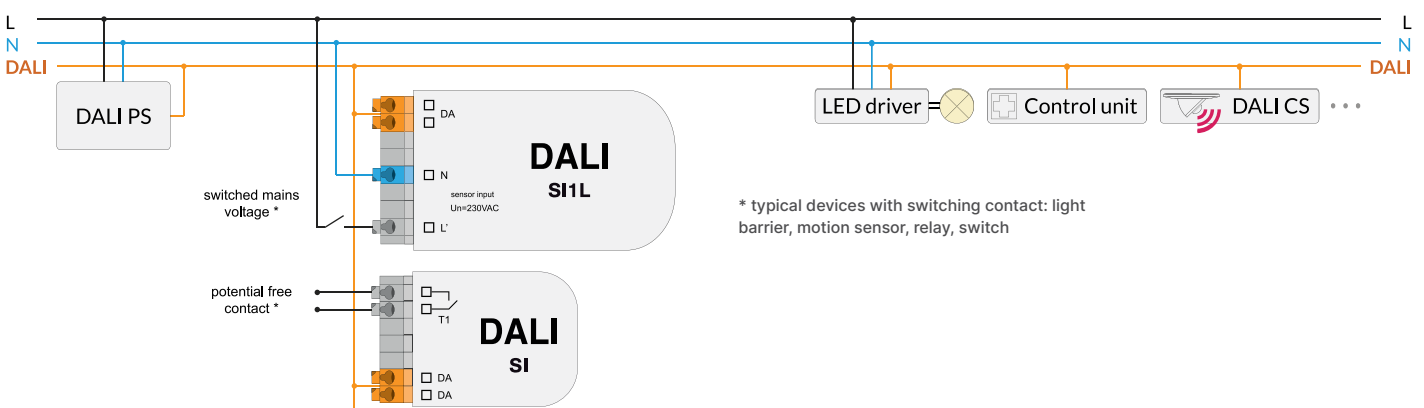



## DALI-2 LS - light sensor

Compact light sensor module for DALI and DALI-2 systems. 2 operating modes are supported: constant light control or light control via 4 threshold values.

The operating mode can easily be changed via scene calls or external DALI commands. The constant light control automatically regulates the light level of individual luminaires or luminaire groups to a user-defined light value. Blinds and roller blinds can be automated via user-defined light thresholds.

The module can either be used to directly control the DALI system (application controller) or simply to gather measurements for a building management system (instance mode). Multiple sensors can be used in one system. The measured values can be read out via the DALI line. The device is powered directly by the DALI bus.

DALI-2 LS is available in three different housings: for direct mounting on cavity walls or installation boxes (standard), for suspended ceilings (with spring), or for surface mounting (with



backbox). Available housing colours are pure white RAL 9010 and traffic white RAL 9016 (-W16).

Factory setting: application controller – master mode, constant light control, target value 500lx, effective range: broadcast

| NAME                                     | ARTICLE NUMBER  | COLOUR  | INTERFACE | SUPPLY        | DALI CURRENT CONSUMPTION | (TA) OPERATING TEMPERATURE | MODEL                                |
|--|-----------------|---------|-----------|---------------|--------------------------|----------------------------|--------------------------------------|
| DALI-2 LS RAL9010                        | 68791433        | RAL9010 | DALI      | via DALI line | typ. 3,5mA               | -20°C ... +60°C            | standard version with mounting holes |
| DALI-2 LS RAL9010 for surface mounting   | 68791433-AP     | RAL9010 | DALI      | via DALI line | typ. 3,5mA               | -20°C ... +60°C            | for surface mounting (with backbox)  |
| DALI-2 LS RAL9010 for suspended ceilings | 68791433-ZD     | RAL9010 | DALI      | via DALI line | typ. 3,5mA               | -20°C ... +60°C            | for suspended ceilings (with spring) |
| DALI-2 LS RAL9016                        | 68791433-W16    | RAL9016 | DALI      | via DALI line | typ. 3,5mA               | -20°C ... +60°C            | standard version with mounting holes |
| DALI-2 LS RAL9016 for surface mounting   | 68791433-W16-AP | RAL9016 | DALI      | via DALI line | typ. 3,5mA               | -20°C ... +60°C            | for surface mounting (with backbox)  |
| DALI-2 LS RAL9016 for suspended ceilings | 68791433-W16-ZD | RAL9016 | DALI      | via DALI line | typ. 3,5mA               | -20°C ... +60°C            | for suspended ceilings (with spring) |

## DALI Temp - temperature sensor

The DALI Temp PT1000 sensor module is used to measure temperatures. Alongside the integrated temperature sensor, an external PT1000 sensing element can be added. The device can be used to control blinds or to monitor luminaire temperatures or temperatures of a heating system. All measured values can be queried via DALI.



| NAME             | ARTICLE NUMBER | SUPPLY        | DALI CURRENT CONSUMPTION | TEMPERATURE MEASUREMENT RANGE (INTERNAL SENSOR) | TEMPERATURE MEASUREMENT RANGE (EXTERNAL PT1000) | DIMENSIONS (MM) |
|------------------|----------------|---------------|--------------------------|---|---|-----------------|
| DALI Temp Sensor | 86459544       | via DALI line | typ. 2,6mA               | 0°C ... +75°C                                   | -25°C ... +125°C                                | 40 × 28 × 15    |

# OVERVIEW FOLDER A-E

## INPUT DEVICES, CONTROL UNITS & SENSORS

[→ open Folder A](#)

|                                      |    |   |    |                                       |    |
|--------------------------------------|----|---|----|---------------------------------------|----|
| DALI-2 Display 4" and 7"             | 2  | wDALI Switch Cross                      | 18 | DALI CDC - time based CW-WW control   | 27 |
| DALI-2 Display 7" Emergency          | 4  | wDALI Remote                            | 19 | DALI-2 RTC+ Timer                     | 28 |
| DALI-2 Display Bus Extension         | 5  | wDALI MC - wireless pushbutton coupler  | 20 | DALI NFC App - settings configuration | 28 |
| DALI-2 Touchpanel                    | 6  | DALI-2 MC - pushbutton coupler          | 20 | DALI Daylight Bluetooth Interface     | 29 |
| DALI Touchpanel                      | 8  | DALI-2 MC1L - pushbutton coupler        | 21 | DALI-2 Audio Interface                | 29 |
| DALI Bluetooth Interface             | 8  | DALI-2 MC4L - pushbutton coupler        | 22 | DALI-2 CS                             | 30 |
| DALI Touchpanel Bluetooth 4.0        | 9  | DALI-2 MC1L PS, MC2L PS                 | 22 | DALI-2 CS Integration THP LE          | 34 |
| DALI-2 KNX Room Controller           | 10 | DALI-2 MC4L POTI - pushbutton coupler   | 23 | DALI-2 CS Mini                        | 35 |
| DALI-2 Room Controller               | 10 | DALI 100K - interface for potentiometer | 23 | DALI-2 CS Corridor                    | 36 |
| DALI Cockpit Mobile - smartphone app | 11 | EnOcean DALI-2 MC                       | 24 | DALI CS with 20mA DALI power supply   | 37 |
| DALI ROT                             | 12 | DALI GC(-A) - controlling 2 DALI groups | 24 | DALI SI, SI-1L                        | 37 |
| DALI-2 ROT                           | 14 | DALI SC(-A) - controlling 4 DALI scenes | 25 | DALI-2 LS - light sensor              | 38 |
| DALI-2 ROT Touch                     | 16 | DALI LR PS 20mA - auto. reduction       | 25 | DALI Temp - temperature sensor        | 38 |
| DALI-2 Switch Cross NFC              | 17 | DALI-2 Sequencer                        | 26 |                                       |    |

## PHASE DIMMER, ACTUATORS & SIGNAL CONVERTERS

[→ open Folder B](#)

|   |   |  |   |  |    |
|---|---|--|---|--|----|
| DALI-2 PD - DALI 230V phase dimmer        | 2 | DALI Jalousie - 230VAC                     | 6 | module with 0/1-10V                      | 7  |
| Relay modules RM8 / RM16                  | 3 | DALI RM8 / RM16 0-10V - relay modules with | 6 | DALI 0/1-10V - converting DALI to 0-10V, | 8  |
| DALI-2 4Ch PD - 4 channel phase dimmer    | 4 | 0-10V input                                | 6 | 1-10V or PWM                             | 8  |
| DALI-2 4Ch E-RM - 4 channel relay control | 4 | DALI RM8 / RM16 2x0-10V - for 2 devices    | 7 | DALI Dim2warm - from DT6 to 2x DT6       | 9  |
| wDALI RM8 - wireless relay module         | 5 | with 0-10V input                           | 7 | DALI DT8 to DT6 - from DT8-Tc to 2x DT6  | 9  |
| DALI 4Ch RC - 4 channel relay control     | 5 | wDALI RM8 0/1-10V PWM - wireless relay     | 7 | 1Ch LED Booster/Dimmer                   | 10 |

## OPERATING DEVICES 230VAC / 48V / 24V

[→ open Folder C](#)

|                                     |   |   |    |   |    |
|-------------------------------------|---|---|----|---|----|
| 1-4 Channels, Constant Voltage (CV) | 4 | CW-WW, RGB, RGBW - Constant Current     | 9  | 230V Operating Devices - DALI LED Power | 12 |
| 1-4 Channels, Constant Current (CC) | 6 | 230V Operating Devices - DALI LED Power | 11 | Supply - Tunable White DT8, CV-CC       | 12 |
| CW-WW, RGB, RGBW - Constant Voltage | 8 | Supply - 1 Channel DT6, CV-CC           | 11 |   |    |

## DALI BUS POWER SUPPLY & EXTENSION

[→ open Folder D](#)

|                                      |   |  |   |                                     |   |
|--------------------------------------|---|--|---|-------------------------------------|---|
| DALI-2 PS - DALI bus power supply    | 2 | wDALI GR-Transwithter - Receiver PS20    | 6 | DALI 4Net - control of 4 DALI lines | 8 |
| DALI-2 Expander - system expansion & |   | wDALI-2 Bluetooth 5 Long Range           |   | DALI-2 Display Bus Extension        | 9 |
| DALI power supply                    | 3 | Transwithter - Receiver                  | 6 | 24V DC Power Supply                 | 9 |
| DALI Proxy                           | 5 | wDALI-2 Bluetooth 5 wireless Bridge      | 7 |                                     |   |
| DALI Repeater                        | 5 | wDALI-2 Extra Long Range wireless Bridge | 7 |                                     |   |

## INTERFACES, TOOLS & GATEWAYS

[→ open Folder E](#)

|   |    |  |    |  |    |
|---|----|--|----|--|----|
| DALI Cockpit - PC software              | 2  | DALI-2 KNX Room Controller                 | 10 | 0-10V DALI - converting 0-10V to DALI with | 17 |
| short introduction on commission a DALI |    | DALI-2 Room Controller                     | 11 | 30mA bus supply                            | 17 |
| system                                  | 2  | DALI Cockpit Mobile - Smartphone App       | 12 | 4-20mA to DALI Converter - 24V, with       | 18 |
| DALI-2 USB 30mA                         | 4  | DALI Daylight Bluetooth Interface          | 13 | 30mA bus supply                            | 18 |
| DALI USB                                | 4  | DALI-2 Audio Interface                     | 13 | 4-20mA to DALI Converter - 230V, with      | 18 |
| DALI Flash USB                          | 5  | DALI SI, SI-1L                             | 14 | 30mA bus supply                            | 18 |
| DALI-2 WLAN Cockpit Interface           | 5  | DALI DSI - converting DALI to DSI          | 14 | DALI RM8 / RM16 0-10V                      | 19 |
| DALI 4Net - control of 4 DALI lines     | 6  | DALI Dim2warm - from DT6 to 2x DT6         | 15 | DALI RM8 / RM16 2x0-10V                    | 19 |
| DALI-2 SCI RS232                        | 7  | DALI DT8 to DT6 - from DT8-Tc to 2x DT6    | 15 | wDALI RM8 0/1-10V PWM - wireless           | 20 |
| DALI-2 RS232 PS - with DALI bus supply  | 7  | 0-10V DALI - converting 0-10V to DALI with | 16 | DALI Yeslousie - 230VAC                    | 20 |
| DALI-2 IoT Gateway                      | 8  | 10mA bus supply                            | 16 | DALI 0/1-10V - converting DALI to 0-10V,   | 21 |
| KNX DALI-2 Gateway                      | 9  | 0-10V DALI - converting 0-10V to DALI with | 17 | 1-10V or PWM                               | 21 |
| KNX 4 DALI Gateway                      | 10 | 1, 2 or 3 channels                         | 17 |  |    |

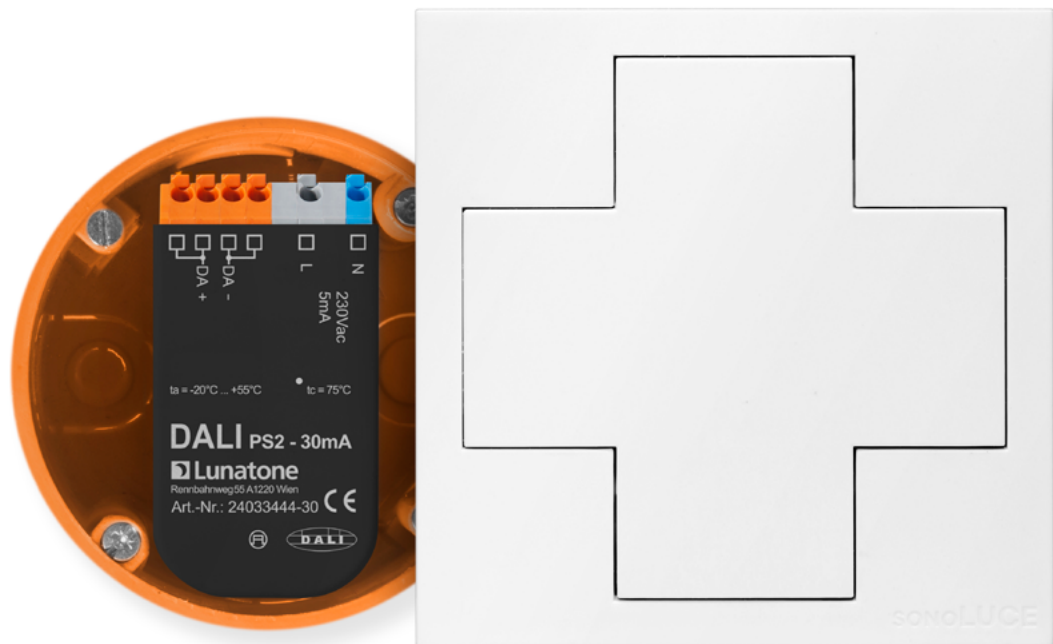

## Lunatone

Lunatone Industrielle Elektronik GmbH

Paukerwerkstrasse 5  
1210 Vienna, Austria

Tel: +43 1 2026400  
E-Mail: [office@lunatone.com](mailto:office@lunatone.com)

[www.lunatone.com](http://www.lunatone.com)