

 Lunatone

DALI BUS POWER SUPPLY & EXTENSION



Folder D



DALI BUS POWER SUPPLY & EXTENSION

Every DALI system requires a DALI bus power supply. Lunatone bus power supplies (DALI PS) are available for various applications, with currents from 30mA up to 250mA and different housing types. A maximum of 64 addresses can be assigned on the DALI bus.

In order to expand the DALI system Lunatone offers various solutions:

- DALI Expander for power supply and bus extension
- DALI Repeater for the extension of the DALI line
- wDALI Transmitter for the wireless integration of devices

TABLE OF CONTENTS

Folder D

DALI-2 PS - DALI bus power supply	2	wDALI-2 Bluetooth 5 wireless Bridge	7
DALI-2 Expander - system expansion & DALI power supply	3	wDALI-2 Extra Long Range wireless Bridge	7
DALI Proxy	5	DALI 4Net - control of 4 DALI lines	8
DALI Repeater	5	DALI-2 Display Bus Extension	9
wDALI GR-Transmitter – Receiver PS20	6	24V DC Power Supply	9
wDALI-2 Bluetooth 5 Long Range Transmitter – Receiver	6	Overview folder A-E	10

DALI-2 PS - DALI bus power supply

Every DALI system requires a DALI bus supply for the DALI communication of the connected controls, sensors and operating devices.

The DALI-2 PS supplies the entire DALI bus with power, depending on the model this can be up to 250mA (see table below). The DALI-2 PS2 30mA is suitable for smaller DALI installations, it can easily be inserted into a flush-mounted installation box due to its small dimensions.

In addition, Lunatone offers DALI bus supplies with 24-48V DC input and DALI output, for example for systems with a 24-volt

on-board network or systems with an emergency power supply. The DALI-2 PS modules are available for DIN rail, suspended ceiling installation (housing with strain relief) or flush-type installation boxes.

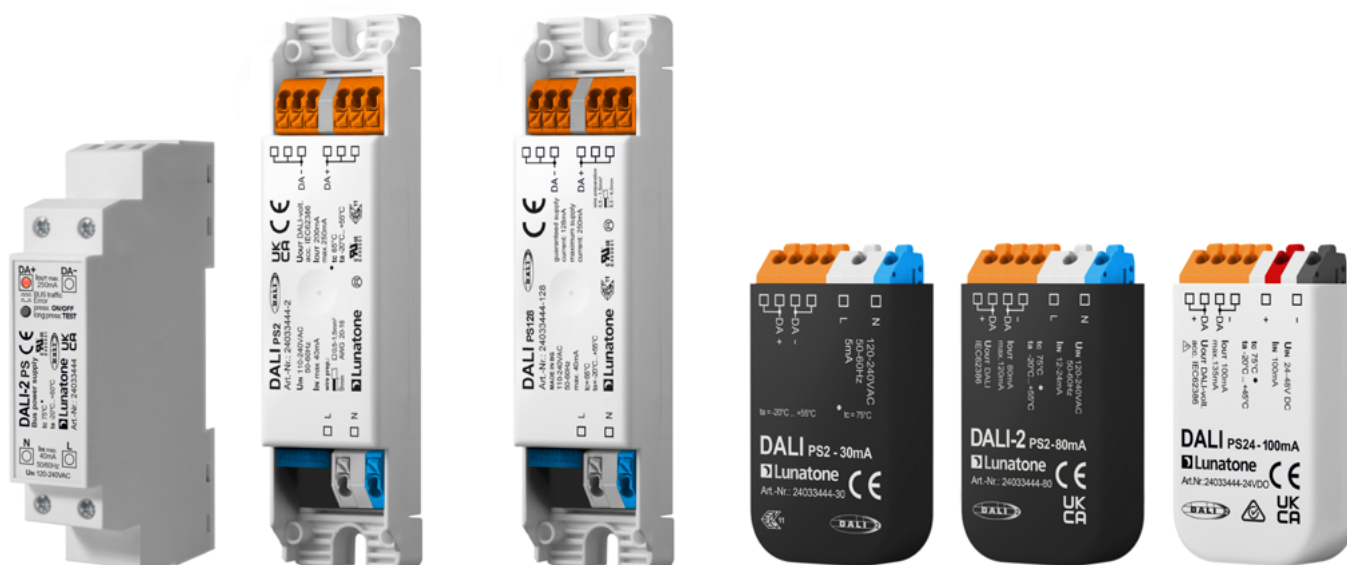

NAME	ARTICLE NUMBER	INPUT VOLTAGE RANGE	GUARANTEED DALI OUTPUT CURRENT (AT 15V)	MAX. DALI OUTPUT CURRENT	OPERATING TEMPERATURE (TA)	MODEL	DIMENSIONS (MM)
DALI-2 PS	24033444	120 - 240V AC	220mA	250mA	-20°C ... +55°C	for DIN rail	98 × 17,5 × 57
DALI-2 PS2	24033444-2	110 - 240V AC	200mA	250mA	-20°C ... +55°C	with strain relief for suspended ceilings	120 × 30 × 22
DALI-2 PS128	24033444-128	110 - 240V AC	128mA	250mA	-20°C ... +55°C	with strain relief for suspended ceilings	120 × 30 × 22
DALI-2 PS2 30mA	24033444-30	120 - 240V AC	30mA	50mA	-20°C ... +55°C	for flush-type installation boxes	59 × 33 × 15
DALI-2 PS2 80mA	24033444-80	120 - 240V AC	80mA	120mA	-20°C ... +55°C	for flush-type installation boxes	59 × 33 × 15
DALI-2 PS24 100mA	24033444-24VDO	24 - 48V DC	100 mA	250mA	-20°C ... +55°C	for flush-type installation boxes	59 × 33 × 15

DALI-2 Expander - intelligent expansion & DALI bus power supply

With the DALI-2 Expander or DALI Expander 3 additional DALI sub-lines can be created and supplied with power and information. The connected operating devices within the DALI sub-line can be controlled broadcast via the address of the DALI-2 Expander. Alternatively the DALI sub-line can also be controlled directly via a pushbutton (input SW&DIM). The devices have an integrated DALI bus power supply for the DALI sub-line. Furthermore, the Expander can also be used to increase the line length by 300m.



NAME	ARTICLE NUMBER	INPUT VOLTAGE	DALI BUS POWER SUPPLY	INPUT	OUTPUT	OPERATING TEMPERATURE (TA)	DIMENSIONS (MM)
DALI-2 Expander DO	89452937-DO	120-240V AC	25mA	DALI	DALI	-20°C ... +55°C	59 × 33 × 15
DALI-2 Expander DIN rail	89452937-HS	120-240V AC	200 mA	DALI / pushbutton	DALI	-20°C ... +55°C	98 × 17,5 × 57
DALI-2 Expander DES	89452937-DES	120-240V AC	200 mA	DALI / pushbutton	DALI	-20°C ... +60°C	120 × 30 × 22
DALI Expander 3	89453847-3	100-240V AC	3 × 50mA	DALI / pushbutton	3x DALI	-20°C ... +60°C	120 × 41 × 22

DALI-2 Expander and DALI Expander 3 as DALI system extension

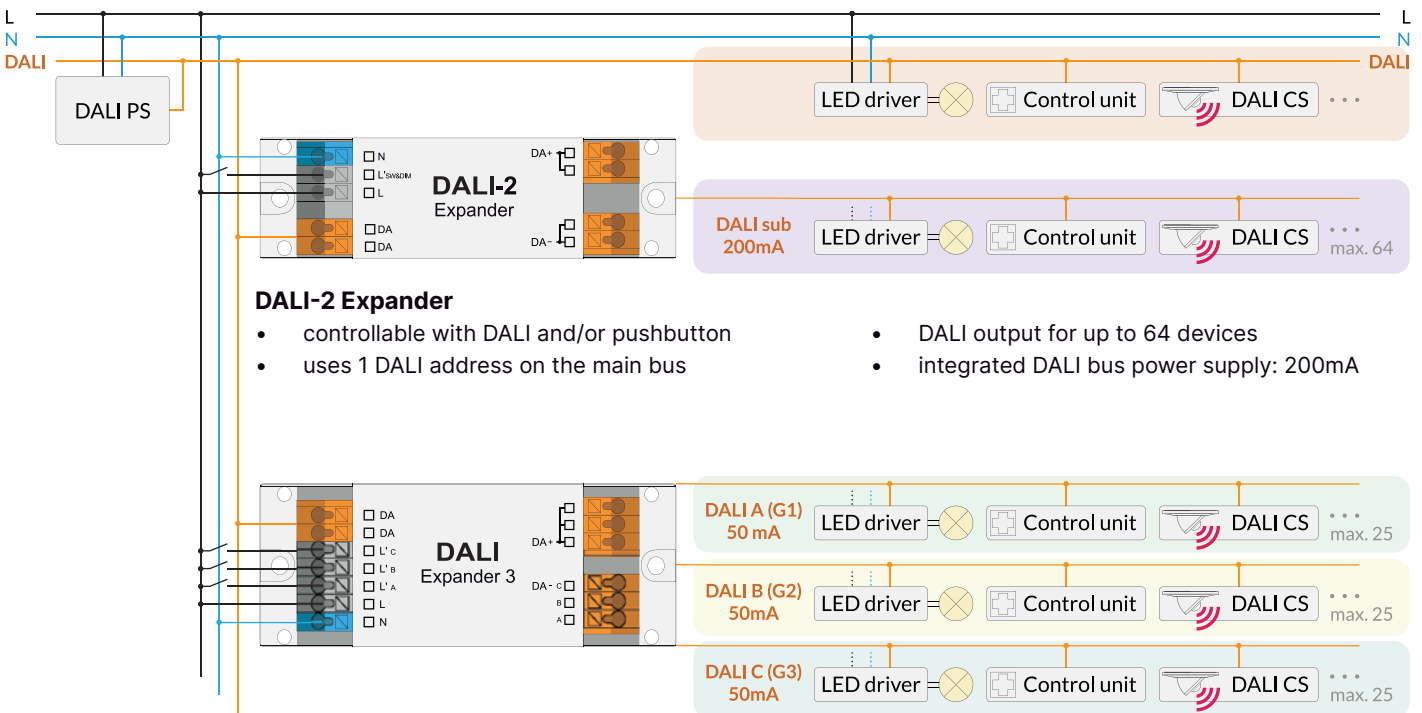

DALI-2 Expander

- controllable with DALI and/or pushbutton
- uses 1 DALI address on the main bus
- DALI output for up to 64 devices
- integrated DALI bus power supply: 200mA

DALI Expander 3

- controllable with DALI and/or pushbutton - 3 pieces
- uses 3 DALI addresses on the main bus
- 3 outputs for up to 25 devices each
- integrated DALI bus power supply: 3x50mA

DALI Proxy

The compact module is used to expand a DALI circuit and allows the devices connected to the output (DALI OUT) to be easily replaced without re-addressing. On the input side (DALI IN) the DALI Proxy represents one device (1 DALI address) and can be handled like any DALI ballast. All commands received by the device are forwarded broadcast to the underlying devices (DALI OUT). Hence the devices connected to DALI OUT can be controlled via the DALI address of the DALI Proxy. With this module the exchange of a lamp or dimmer is possible without re-addressing!



NAME	ARTICLE NUMBER	INPUT	TYP. DALI CURRENT CONSUMPTION	OUTPUT	DALI BUS POWER SUPPLY	OPERATING TEMPERATURE (TA)	DIMENSIONS (MM)
DALI Proxy	89452887	DALI control input	2mA + Iout	DALI (DA+, DA-)	2x 4mA	-20°C ... +55°C	59 x 33 x 15

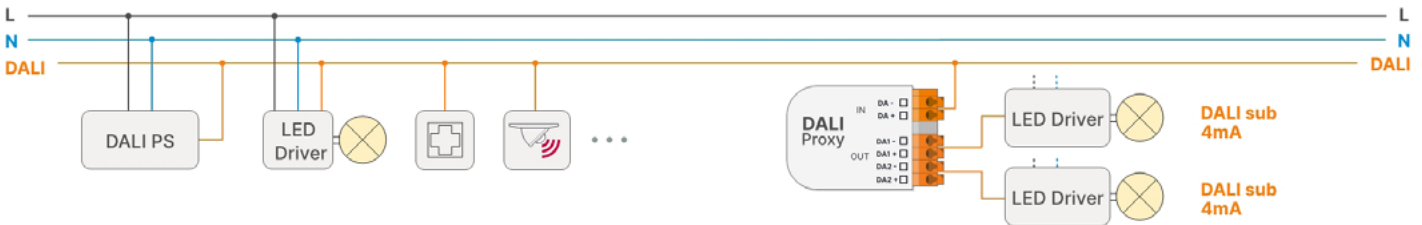

DALI Repeater

DALI installations have a maximum range of 300 meters. For larger installations, a DALI Repeater can be used to amplify signals and extend the installation by an additional 300m. The DALI Repeater provides a galvanic isolation between DALI input and DALI output. The device supports bidirectional communication and can be used in DALI systems with multiple control devices (multi-master systems and DT8). The DALI Repeater is available in two versions: Art. Nr.:86458401 in a DIN rail housing for the control cabinet and Art.Nr.:86458401-PS with strain relief for suspended ceiling installation and integrated DALI bus power supply for the output.



NAME	ARTICLE NUMBER	STROM-VERSORGUNG	TYP. DALI CURRENT CONSUMPTION	DALI BUS POWER SUPPLY	MODEL	DIMENSIONS (MM)
DALI Repeater DIN rail	86458401	via DALI line	6mA	-	for DIN rail	98 x 17,5 x 57
DALI Repeater PS DIN rail	86458401-PS-HS	via DALI line / 100-240V AC	2mA	200mA	for DIN rail	98 x 17,5 x 57
DALI Repeater PS	86458401-PS	via DALI line / 100-240V AC	2mA	200mA	with strain relief for suspended ceilings	120 x 41 x 22

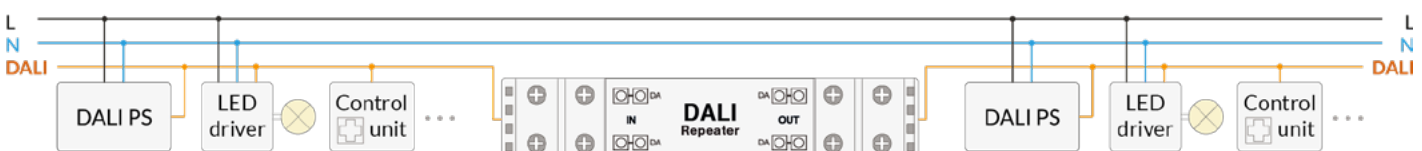

wDALI GR-Transmitter – Receiver PS20

wDALI GR Transmitter / Receiver PS is an interface to wirelessly integrate DALI devices into the DALI system. The transmitter is connected to the main DALI bus. The receiver forms a DALI sub-line that wirelessly receives commands from the main bus. A group can be assigned to the wDALI Receiver using the dial on the device's housing. Commands on the main line directed to this group are forwarded to the entire sub-line. The wDALI Receiver PS20 has a 230V AC input and supplies the DALI sub-line with 20mA for up to 10 DALI devices.



NAME	ARTICLE NUMBER	FEATURES	FREQUENCY	SUPPLY	DALI POWER SUPPLY	RANGE	OPERATING TEMP. (TA)	DIMENSIONS (MM)
wDALI GR Transmitter	86459587-GRTM	<ul style="list-style-type: none"> wireless transmission of DALI commands 	2.4 GHz	via DALI line (3.8mA)	-	<ul style="list-style-type: none"> up to 150m outdoors indoors typically 8m-12m 	-20°C...+75°C	59×33×15
wDALI GR Receiver PS20	86459587-GRRPS	<ul style="list-style-type: none"> wireless reception of DALI commands dial on the device for group selection commands to the assigned group are broadcasted to the sub-line 	2.4 GHz	mains voltage 210-250VAC 50-60Hz	20mA	<ul style="list-style-type: none"> up to 150m outdoors indoors typically 8m-12m 	-20°C...+60°C	59×33×15

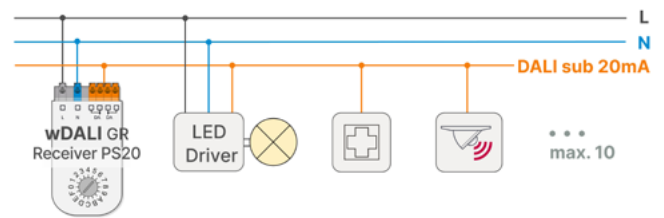
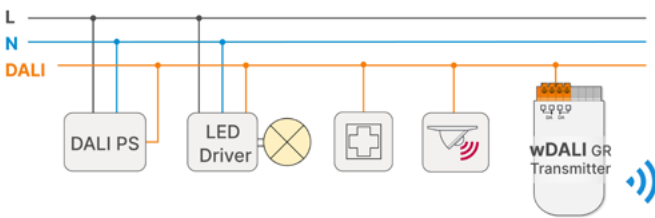

wDALI-2 Bluetooth 5 Long Range Transmitter – Receiver



Module to wirelessly connect spatially separated DALI loads to a DALI system with Bluetooth 5 Long Range. The transmitter sends DALI commands from the DALI system to one or more receivers. The receiver is available with or without an integrated DALI bus supply. The devices on the sub-line can be controlled via broadcast or an assigned group. Easy configuration with the PC software DALI Cockpit. Support of DALI-2 control commands.



NAME	ARTICLE NUMBER	FEATURES	FREQUENCY RANGE	SUPPLY	DALI POWER SUPPLY	RANGE	OPERATING TEMP. (TA)	DIMENSIONS (MM)
wDALI-2 BT5 Long Range Transmitter	89453321-GRTM	<ul style="list-style-type: none"> wireless transmission of DALI commands: Bluetooth 5 Long Range 	2.4 GHz	via DALI line (3.8mA)	-	<ul style="list-style-type: none"> up to 300m outdoors indoors typically 10m-20m 	-20°C...+75°C	59×33×15
wDALI-2 BT5 Long Range Receiver	89453321-GRR	<ul style="list-style-type: none"> wireless reception of DALI commands group assignment: DALI Cockpit 	2.4 GHz	via DALI line (3.8mA)	-	<ul style="list-style-type: none"> up to 300m outdoors indoors typically 10m-20m 	-20°C...+75°C	59×33×15
wDALI-2 BT5 Long Range Receiver PS20	89453321-GRRPS	<ul style="list-style-type: none"> commands to the assigned group are broadcasted to the sub-line 	2.4 GHz	mains voltage 210-250VAC / 50-60Hz	20mA	<ul style="list-style-type: none"> up to 300m outdoors indoors typically 10m-20m 	-20°C...+60°C	59×33×15

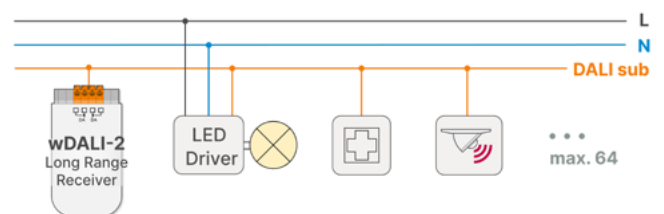
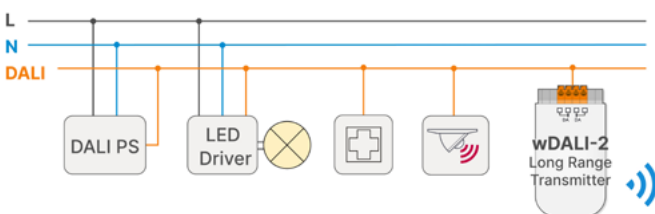

wDALI-2 Bluetooth 5 wireless Bridge

Module to wirelessly connect spatially separated DALI lines (Bluetooth 5). The wireless connection is bidirectional – control is possible from both DALI lines. Additionally, DALI queries are supported. The wireless connection is set up using the PC software DALI Cockpit. The device connected to the DALI Cockpit can be set to Master mode and wirelessly searches for all other modules (Slaves) within range. The Slaves can then be paired with the Master via the Cockpit software. After pairing, the DALI devices on the Slave-DALI-lines can be addressed and configured wirelessly via the wireless DALI bridge that has been set



up. Version with integrated DALI power supply (Art. Nr. 89453348-PS), provides 20mA for the sub-line (up to 10 DALI ballasts).

NAME	ARTICLE NUMBER	FEATURES	FREQUENCY RANGE	SUPPLY	DALI POWER SUPPLY	RANGE	OPERATING TEMP. (TA)	DIMENSIONS (MM)
wDALI-2Bluetooth 5 wireless Bridge	89453348	<ul style="list-style-type: none"> bidirectional connection: wireless control and query of DALI devices between main and sub-lines 	2.4 GHz	via DALI line (2mA)	-	<ul style="list-style-type: none"> up to 300m outdoors indoors typically 10m-20m 	-20°C...+55°C	59×33×15
wDALI-2Bluetooth 5 wireless Bridge PS20	89453348-PS	<ul style="list-style-type: none"> configurable operating mode: Master or Slave 	2.4 GHz	mains voltage 210-250VAC 50-60Hz	20mA	<ul style="list-style-type: none"> up to 300m outdoors indoors typically 10m-20m 	-20°C...+55°C	59×33×15

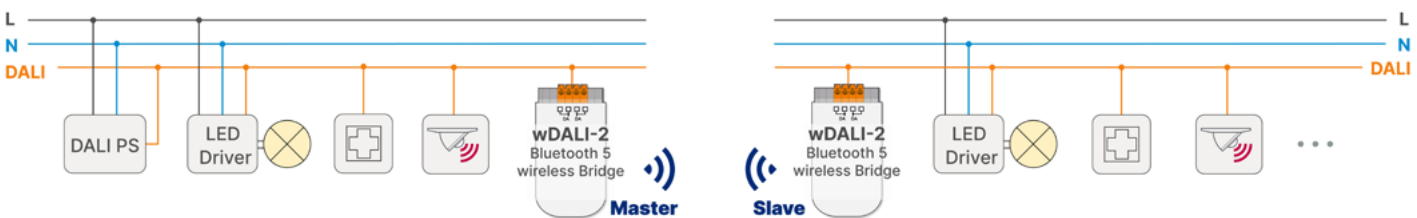

wDALI-2 Extra Long Range wireless Bridge

Module to wirelessly connect spatially separated DALI lines (LoRa). The wireless connection is bidirectional – control is possible from both DALI lines. Additionally, DALI queries are supported. The wireless connection is set up using the PC software DALI Cockpit. The device connected to the DALI Cockpit can be set to Master mode and wirelessly searches for all other modules (Slaves) within range. The Slaves can then be paired with the Master via the Cockpit software. After pairing, the DALI devices on the Slave-DALI-lines can be addressed and configured wirelessly via the wireless DALI bridge that has been set up.

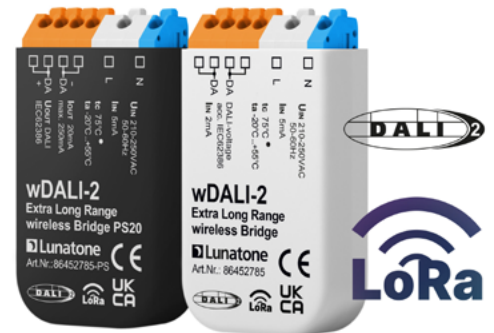

Version with integrated DALI power supply (Art. Nr. 86452785-PS), provides 20mA for the sub-line (up to 10 DALI ballasts).

NAME	ARTICLE NUMBER	FEATURES	FREQUENCY RANGE	SUPPLY	DALI POWER SUPPLY	RANGE	OPERATING TEMP. (TA)	DIMENSIONS (MM)
wDALI-2 Extra Long Range wireless Bridge	86452785	<ul style="list-style-type: none"> bidirectional connection: wireless control and query of DALI devices between main and sub-lines 	E-LORA 868 MHz	via DALI line (2mA), 210-250VAC / 50-60Hz	-	<ul style="list-style-type: none"> up to 1km outdoors indoors typically 100m-500m 	-20°C...+55°C	59×33×15
wDALI-2 Extra Long Range wireless Bridge PS20	86452785-PS	<ul style="list-style-type: none"> configurable operating mode: Master or Slave 	E-LORA 868 MHz	mains voltage 210-250VAC / 50-60Hz	20mA	<ul style="list-style-type: none"> up to 1km outdoors indoors typically 100m-500m 	-20°C...+55°C	59×33×15



DALI 4Net - control of 4 DALI lines

The compact 1DU DIN rail module enables the independent control of up to 4 DALI lines, which equals 256 DALI operating devices. Efficient scaling is possible with external DALI bus supplies.

The DALI 4Net module enables cross-DALI line control using 15 cross-bus zones. The DALI groups from the 4 DALI lines can be assigned to these zones. This makes it possible to extend the effective range of a command beyond its DALI line.

Furthermore, the "Trigger Action" function of the DALI 4Net module enables control devices from one DALI bus to control areas of the other 3 DALI buses.

DALI devices and DALI LED dimmers can be configured via the PC software tool DALI Cockpit via the Ethernet interface of the DALI 4Net.

With the Modbus interface, the DALI 4Net can also be integrated into building management systems (BMS).

The DALI 4Net is available in a basic version with limited functions (see table), or in an extended version with real time clock (RTC), circadian daylight schedules (CDC), programmable



schedules, cross-line functions for input devices and sensors, emergency function and sensor value recording. Information from the DALI operating devices can be read and displayed using the PC software tool DALI Visual.

NAME	ARTICLE NUMBER	INTERFACE	POWER SUPPLY	BASIC FUNCTIONS	ADDITIONAL FUNCTIONS	DIMENSIONS (MM)
DALI 4Net Basic	22176666-B	4xDALI, Ethernet	24V DC	<ul style="list-style-type: none"> gateway Modbus ↔ DALI ModBus TCP control ModBus TCP queries zone definition (areas over multiple lines) 	-	98 × 17,5 × 57
DALI 4Net	22176666	4xDALI, Ethernet	24V DC		<ul style="list-style-type: none"> real time clock central scheduling cross-line functions circadian daylight schedule emergency function sensor value polling 	98 × 17,5 × 57

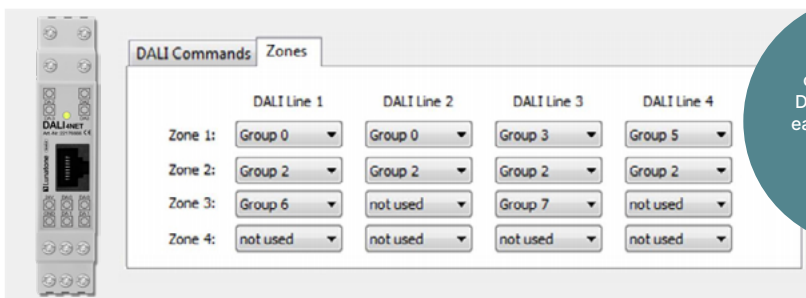
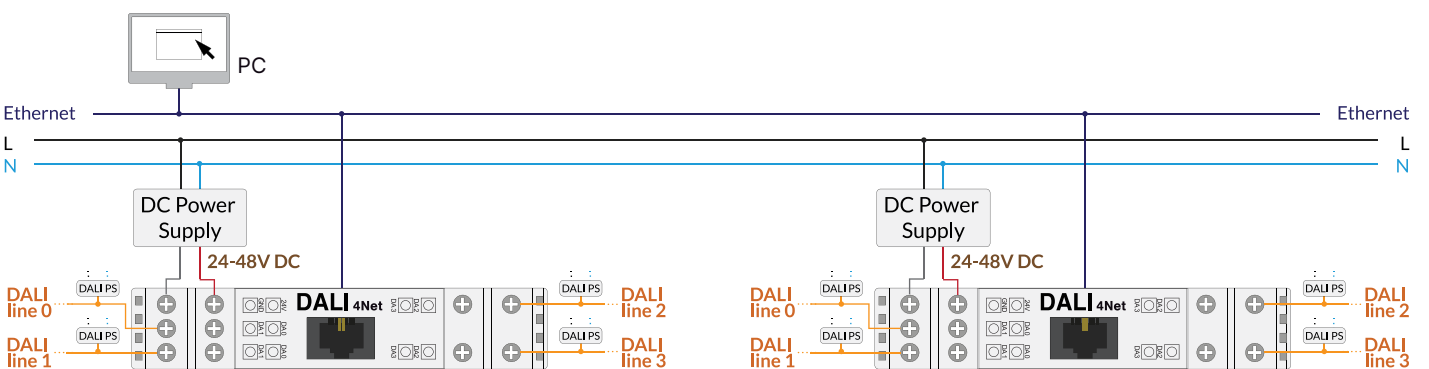

15 zones can be defined. DALI groups from each DALI line can be assigned to these zones.

"Cross-line operations" allow sending commands to multiple DALI lines or a user defined zone.

DALI-2 Display Bus Extension

The module is used in combination with a DALI-2 Display 7" Plus or DALI-2 Display 7" Emergency. It allows a DALI system expansion with up to 3 additional DALI lines. The device has 2 Ethernet sockets for connecting the DALI-2 Display and the local network. Up to three DALI lines can be connected via terminals DA1, DA2 and DA3.

The Display Bus Extension Module requires a 24V supply (suitable power supply unit: PS 24V, 300mA, Art. Nr.: 24166012-24HS). The DIN rail housing is suitable for installation in control cabinets.



NAME	ARTICLE NUMBER	DESCRIPTION	INTERFACE	COMPATIBILITY	POWER SUPPLY	DIMENSIONS (MM)
DALI-2 Display Bus Extension	86451848	DALI System Extension for the DALI-2 Display 7" Plus and DALI-2 Display 7" Emergency	network socket - Ethernet network socket - Display	86456840-P 86456840-EM 86456840- P-EM	24VDC	98×18×56

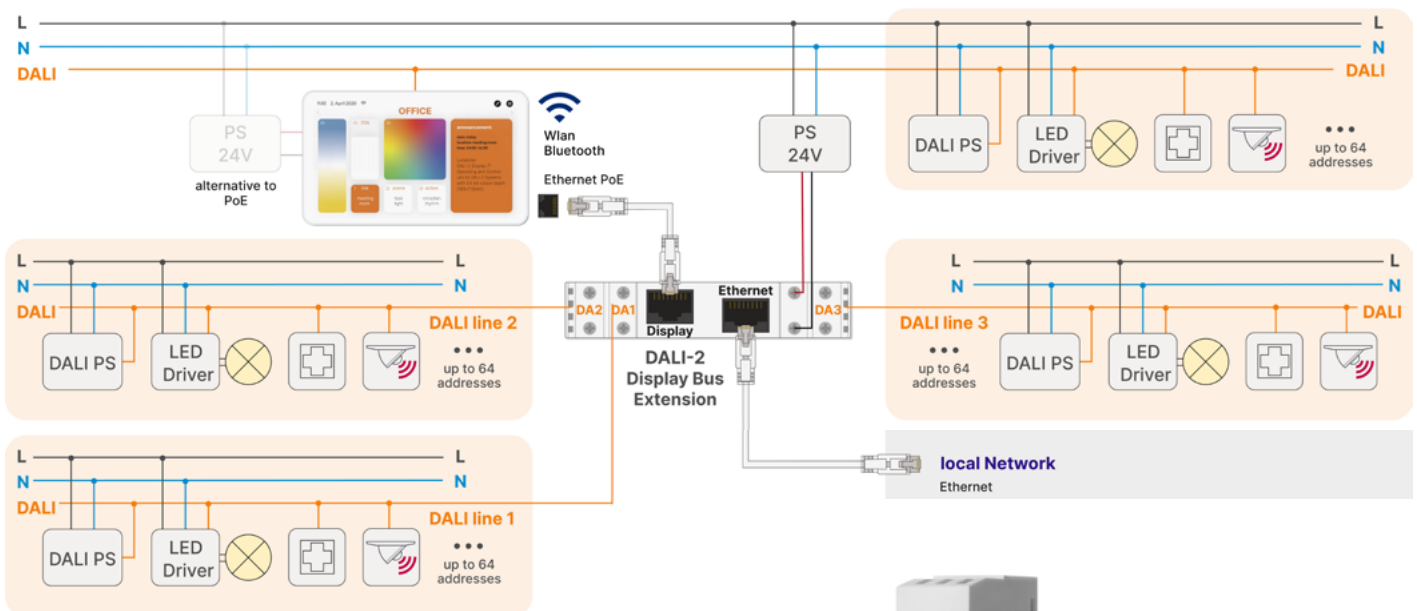

24V DC Power Supply

Module for DIN rail mounting with up to 300mA output current.
Module for the installation box with either 60mA or 130mA output current.



NAME	ARTICLE NUMBER	INPUT VOLTAGE	INPUT-CURRENT	OUTPUT-VOLTAGE	OUTPUT-CURRENT	OPERATING TEMP. (TA)	MODEL	DIMENSIONS (MM)
PS 24V 300mA	24166012-24HS	230 V AC	50 mA	24V DC	max. 300mA	-20°C ... +55°C	for DIN rail	98 × 17,5 × 57
PS 24V 130mA	24166130-24	230 V AC	18 mA	24V DC	max. 130mA	-20°C ... +55°C	for flush-type installation boxes	59 × 33 × 15
PS 24V 60mA	24166012-24	230 V AC	15 mA	24V DC	max. 60mA	-20°C ... +55°C	for flush-type installation boxes	59 × 33 × 15

OVERVIEW FOLDER A-E

INPUT DEVICES, CONTROL UNITS & SENSORS

[→ open Folder A](#)

DALI-2 Display 4" and 7"	2	wDALI Switch Cross	18	DALI CDC - time based CW-WW control	27
DALI-2 Display 7" - Emergency	4	wDALI Remote	19	DALI-2 RTC+ Timer	28
DALI-2 Display Bus Extension	5	wDALI MC - wireless pushbutton coupler	20	DALI NFC App - settings configuration	28
DALI-2 Touchpanel	6	DALI-2 MC - pushbutton coupler	20	DALI Daylight Bluetooth Interface	29
DALI Touchpanel	8	DALI-2 MC1L - pushbutton coupler	21	DALI-2 Audio Interface	29
DALI Bluetooth Interface	8	DALI-2 MC4L - pushbutton coupler	22	DALI-2 CS	30
DALI Touchpanel Bluetooth 4.0	9	DALI-2 MC1L PS, MC2L PS	22	DALI-2 CS Integration THP LE	34
DALI-2 KNX Room Controller	10	DALI-2 MC4L POT1 - pushbutton coupler	23	DALI-2 CS Mini	35
DALI-2 Room Controller	10	DALI 100K - interface for potentiometer	23	DALI-2 CS Corridor	36
DALI Cockpit Mobile - smartphone app	11	EnOcean DALI-2 MC	24	DALI CS with 20mA DALI power supply	37
DALI ROT	12	DALI GC(-A) - controlling 2 DALI groups	24	DALI SI, SI-1L	37
DALI-2 ROT	14	DALI SC(-A) - controlling 4 DALI scenes	25	DALI-2 LS - light sensor	38
DALI-2 ROT Touch	16	DALI LR PS 20mA - auto. reduction	25	DALI Temp - temperature sensor	38
DALI-2 Switch Cross NFC	17	DALI-2 Sequencer	26		

PHASE DIMMER, ACTUATORS & SIGNAL CONVERTERS

[→ open Folder B](#)

DALI-2 PD - DALI 230V phase dimmer	2	DALI Jalousie - 230VAC	6	module with 0/1-10V	7
Relay modules RM8 / RM16	3	DALI RM8 / RM16 0-10V - relay modules with		DALI 0/1-10V - converting DALI to 0-10V,	
DALI-2 4Ch PD - 4 channel phase dimmer	4	0-10V input	6	1-10V or PWM	8
DALI-2 4Ch E-RM - 4 channel relay control	4	DALI RM8 / RM16 2x0-10V - for 2 devices		DALI Dim2warm - from DT6 to 2x DT6	9
wDALI RM8 - wireless relay module	5	with 0-10V input	7	DALI DT8 to DT6 - from DT8-Tc to 2x DT6	9
DALI 4Ch RC - 4 channel relay control	5	wDALI RM8 0/1-10V PWM - wireless relay		1Ch LED Booster/Dimmer	10

OPERATING DEVICES 230VAC / 48V / 24V

[→ open Folder C](#)

1-4 Channels, Constant Voltage (CV)	4	CW-WW, RGB, RGBW - Constant Current	9	230V Operating Devices - DALI LED Power	
1-4 Channels, Constant Current (CC)	6	230V Operating Devices - DALI LED Power		Supply - Tunable White DT8, CV-CC	12
CW-WW, RGB, RGBW - Constant Voltage	8	Supply - 1 Channel DT6, CV-CC	11		

DALI BUS POWER SUPPLY & EXTENSION

[→ open Folder D](#)

DALI-2 PS - DALI bus power supply	2	wDALI GR-Transwithter - Receiver PS20	6	DALI 4Net - control of 4 DALI lines	8
DALI-2 Expander - system expansion &		wDALI-2 Bluetooth 5 Long Range		DALI-2 Display Bus Extension	9
DALI power supply	3	Transwithter - Receiver	6	24V DC Power Supply	9
DALI Proxy	5	wDALI-2 Bluetooth 5 wireless Bridge	7		
DALI Repeater	5	wDALI-2 Extra Long Range wireless Bridge	7		

INTERFACES, TOOLS & GATEWAYS

[→ open Folder E](#)

DALI Cockpit - PC software	2	DALI-2 KNX Room Controller	10	0-10V DALI - converting 0-10V to DALI with	
short introduction on commission a DALI		DALI-2 Room Controller	11	30mA bus supply	17
system	2	DALI Cockpit Mobile - Smartphone App	12	4-20mA to DALI Converter - 24V, with	
DALI-2 USB 30mA	4	DALI Daylight Bluetooth Interface	13	30mA bus supply	18
DALI USB	4	DALI-2 Audio Interface	13	4-20mA to DALI Converter - 230V, with	
DALI Flash USB	5	DALI SI, SI-1L	14	30mA bus supply	18
DALI-2 WLAN Cockpit Interface	5	DALI DSI - converting DALI to DSI	14	DALI RM8 / RM16 0-10V	19
DALI 4Net - control of 4 DALI lines	6	DALI Dim2warm - from DT6 to 2x DT6	15	DALI RM8 / RM16 2x0-10V	19
DALI-2 SCI RS232	7	DALI DT8 to DT6 - from DT8-Tc to 2x DT6	15	wDALI RM8 0/1-10V PWM - wireless	20
DALI-2 RS232 PS - with DALI bus supply	7	0-10V DALI - converting 0-10V to DALI with		DALI Yeslousie - 230VAC	20
DALI-2 IoT Gateway	8	10mA bus supply	16	DALI 0/1-10V - converting DALI to 0-10V,	
KNX DALI-2 Gateway	9	0-10V DALI - converting 0-10V to DALI with		1-10V or PWM	21
KNX 4 DALI Gateway	10	1, 2 or 3 channels	17		

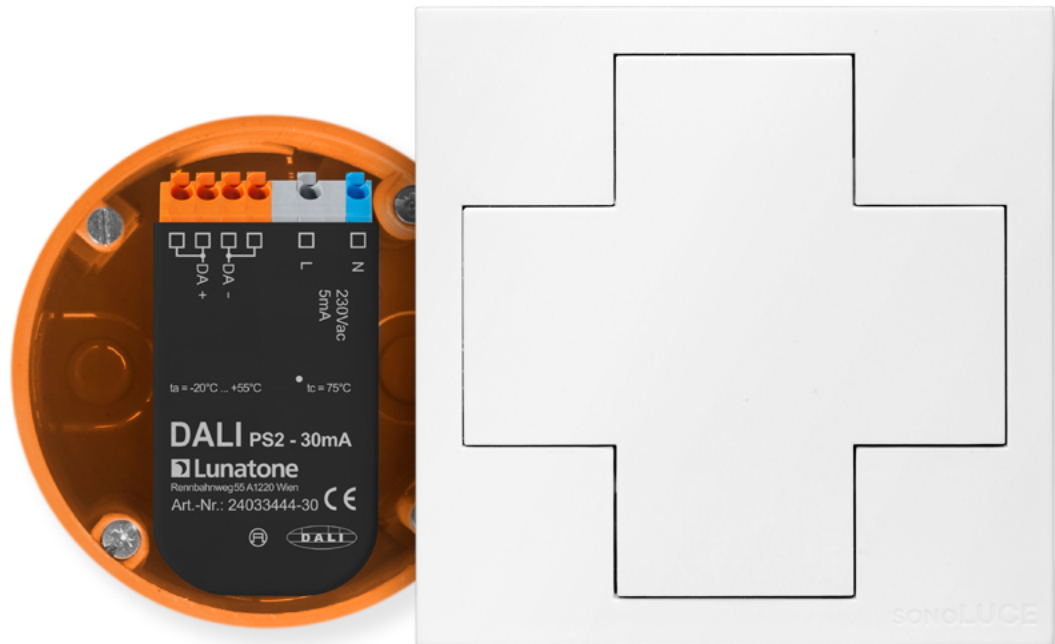

Lunatone

Lunatone Industrielle Elektronik GmbH

Paukerwerkstrasse 5
1210 Vienna, Austria

Tel: +43 1 2026400
E-Mail: office@lunatone.com

www.lunatone.com